

Systems Reference Library

IBM 1231, 1232 Optical Mark Page Readers

This publication describes the functions, controls, principles of operation, data flow, and programming for the IBM 1231 and 1232 Optical Mark Page Readers. Special features available are explained. Also included is a section on the IBM 534 Model 3 Card Punch.

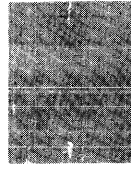
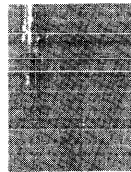
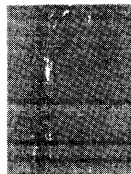
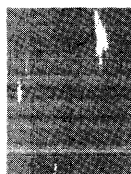
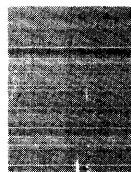
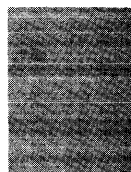
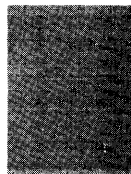

This publication, form A21-9012-3, replaces and obsoletes form A21-9012-2. Information from technical newsletter N21-0023 is included. Changes to text are indicated by a vertical line to the left of the column. Changes to illustrations are indicated by a bullet (●) to the left of the figure title.

Copies of this and other IBM publications can be obtained through IBM Branch Offices. Address comments concerning the content of this publication to:
IBM, Product Publications Department, Rochester, Minn. 55901.

Contents

IBM 1231 and 1232 Optical Mark Page Readers	5
Data Sheet	8
Data Sheet Terminology	8
Marking the Data Sheet	8
Principles of Operation	10
Document Path	10
Feed Hopper	10
Feed and Transport Mechanism	10
Selector Station and Stackers	11
Reading	12
Read Unit	12
Mark Recognition and Discrimination	12
Data Flow	13
IBM 1231 Data Flow	13
IBM 1231 Message Format	14
IBM 1232 Data Flow	14
IBM 1232 Message Format	15
IBM 1232/534 Synchronization Check	15
Field Checking	16
Alphabetic Coding	19
Controls	19
Keys and Switches	20
Lights	21
Programming	22
Program Control Sheet	22
On-Line Systems Programming	24
On-Line Program Instructions	26
Operating Procedures	27
IBM 1232 Setup	27
IBM 534 Setup	27
IBM 1231 Setup	27
Restart Procedures	28
Special Features	31
Master Mark Feature	31
Segmented Word Feature	31
Special Card Features	31
Multiple Spread-Card Feature	32
Unit Record Card Feature	34
IBM 534 Model 3 Card Punch	38
Punch Controls	38
Programming	38
Throughput Factors	40
1231 Throughput	40
1232/534 Throughput	40
Document Design and Specifications	42
Specifications	42
Paper Requirements	42
Burst Continuous Forms	42
Ink Requirements	44
Document Format Requirements	44
Printing Requirements	44
Design Guides	46
Document Gage	49
Index	51



IBM 1231 with IBM 1401 Data Processing System

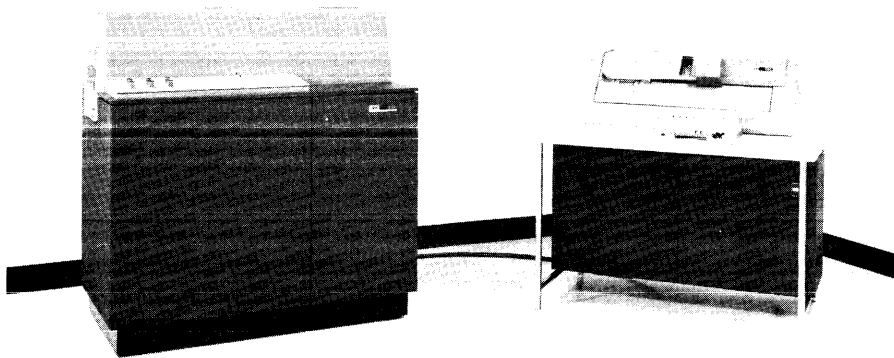

IBM 1232 with IBM 534 Model 3 Card Punch

IBM 1231 and 1232 Optical Mark Page Readers

During the past several years many changes and advances have been made in the field of data processing. Computer access times have diminished from many milliseconds to a few microseconds. Printing speeds have risen from 100 lines a minute to well over 1000 lines a minute. Programming systems have become problem oriented, easier and cheaper to use.

Although these significant advances have taken place in the processing and output areas of data processing, no significant improvements have been made in the methods by which source data is recorded and entered into these systems.

The IBM 1231 and 1232 Optical Mark Page Readers represent a breakthrough in the area of source recording and data entry. They provide a facility for recording the data at its source, in a form that can be converted directly into data processing language.

The IBM Optical Mark Page Readers read positional marks made by an ordinary lead pencil on paper documents. The positional marks are converted into a machine-usable form by the 1231 and entered directly into a data processing system; or the marks are read and the information punched into cards by the 1232.

Documents are read in the 1231 and the 1232 at a maximum rate of 2000 sheets per hour. Throughput for the 1232 depends upon the format of the data sheet, the number of card columns to be punched, and the number of cards per data sheet. The 1231 throughput depends on computer programming, the feed mode (Continuous or On-Demand), and the method of grouping the data on the data sheet. (When identification data and detail data are interspersed and read into 1231 storage, more program steps are needed to separate the data in the computer.)

The 1231 (Figure 1), therefore, acts as an on-line input device to data processing systems, such as, IBM 1401, IBM 1440, and IBM 1460.

The 1231 is a fully-buffered machine that operates at an average document cycle of 1730ms in continuous feed mode. Variations in data-sheet feeding can cause a document cycle to be as short as 1585ms. The maximum time to transfer data from the 1231 buffered storage to the computer is 7.2ms. Therefore, 1585ms minus 7.2ms, or 1577ms can be safely used as processing time by the computer. Thus, 1231 sub-routines can be inserted into routines of other applications.

The IBM 1232, when operating with an IBM 534

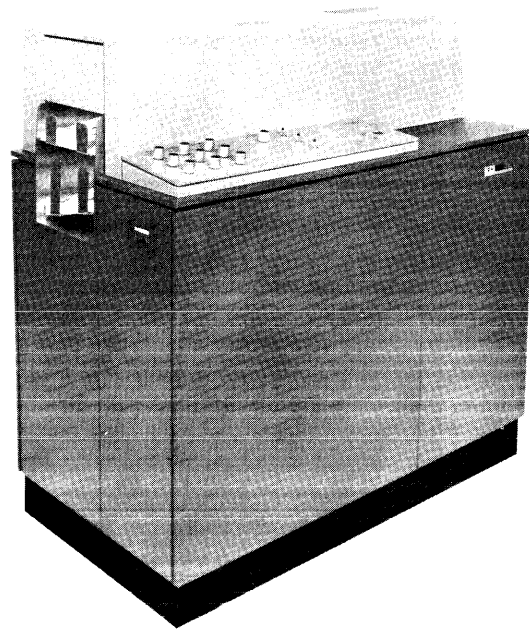

Figure 1. IBM 1231 Optical Mark Page Reader

Model 3 Card Punch, can convert data into punched cards directly from the source documents. Conversion speed can be as high as 64,000 characters per hour, or 800 fully-punched cards per hour.

Optical Mark Page Readers are ideally suited for applications such as: order entry, payroll, accounts payable, inventory control, sales analysis, and general ledger work.

The 8 1/2" x 11" data sheet is a versatile document, adaptable to many applications. One of its uses may be as an order entry form (Figure 2). Insurance companies could use the data sheet in areas such as; debit route accounting, policy applications, or policy rating (Figure 3). Medical centers may find the data sheet and its subsequent processing convenient for patient billing, clinical analysis, or medical histories. Other areas of business such as; marketing research and survey companies, schools and stock brokers will also find applications for the data sheet and its processing.

By means of stored program controls, the IBM 1231 and the IBM 1232 can:

- Control specific data to be stored.
- Control data that is to be repetitively punched into cards.
- Identify the end of a field.

ANY INSURANCE COMPANY ROUTE LIST

COLLECTION WEEK 935 DAY 2 DEBIT 1152

FINANCIAL CERTIFICATION

AGENT'S SIGNATURE:

ACCOUNT NUMBER	SELECTED COLLECTION	D. L. R.	AMT.	ADV.	AMOUNT	PREMIUM	NUMBER OF PAYMENTS
2034	296	5933	2			296	1 2 3 4 5
2035	295	5933	2			295	1 2 3 4 5
2038		5930	5			246	1 2 3 4 5
2043	10	5934	1			10	1 2 3 4 5
2045	337	5934	1			337	1 2 3 4 5
2150	530	5934	1			265	1 2 3 4 5
2157	362	5934	1			362	1 2 3 4 5
2165	110	5933	2			110	1 2 3 4 5
2180		5935				145	1 2 3 4 5
2182	105	5935				105	1 2 3 4 5
2185		5935				142	1 2 3 4 5
2190		5932	3			89	1 2 3 4 5
2195		5932	3			225	1 2 3 4 5
2197		5932	3			70	1 2 3 4 5
2198	450	5933	2			225	1 2 3 4 5
2203		5929	6			120	1 2 3 4 5
2209		5934	1			30	1 2 3 4 5
2210	120	5933	2			120	1 2 3 4 5
2213	105	5933	2			105	1 2 3 4 5
2214	197	5934	1			197	1 2 3 4 5
2215	30	5939	4			30	1 2 3 4 5
2216		5934	1			120	1 2 3 4 5
2218	125	5934	1			125	1 2 3 4 5
2220	50	5934	1			50	1 2 3 4 5
2225	120	5934	1			120	1 2 3 4 5
2230	130	5940	5			130	1 2 3 4 5
2240		5941	6			49	1 2 3 4 5
2241		5933	2			10	1 2 3 4 5
2250	255	5933	2			255	1 2 3 4 5
2255	75	5934	1			75	1 2 3 4 5
2255	150	5934	1			150	1 2 3 4 5
2260	336	5934	1			336	1 2 3 4 5
2262	76	5934	1			76	1 2 3 4 5
2262	282	5934	1			282	1 2 3 4 5
2275		5934	1			165	1 2 3 4 5

Make your marks with a black lead pencil. Erase completely any marks changed.

ANY LIFE INSURANCE COMPANY

INDUSTRIAL APPLICATION

Erase completely any marks changed.

DATE OF POLICY POLICY NUMBER

1 YOUR FULL NAME (Print) P O L I C Y

2 RESIDENCE (Print) NO. CITY OR TOWN STATE ZIP

3 PLACE OF BIRTH DATE OF BIRTH SEX LAST BIRTHDAY

4 OCCUPATION (Print) FULL NAME

5 HEIGHT AND WEIGHT IN POUNDS

6 IF YES, WHICH IF YES, WHICH

7 POLICY APPLIED FOR FACE AMOUNT PURCHASED

8 PLAN

9 OCCUPATION, JAN. 1, 1954, AND NATURE OF WORK PERFORMED

10 PREVIOUSLY AVAILABLE

11 CLASSIFICATION

12 SIGNATURE OF APPLICANT

13 SIGNATURE OF WITNESS

14 RELATIONSHIP OF BENEFICIARY

15 HAVE YOU ANY PHYSICAL DEFECT OR IMPAIRMENT OF HEALTH?

16 HAVE YOU BEEN DECLINED, POSTPONED, OR YOUR POLICY CANCELLED BY ANY OTHER COMPANY?

17 DOES EMPLOYER PAID IN SOME STATE IN WHICH EMPLOYER IS LOCATED?

18 REPORT OF FIELD REPRESENTATIVE

19 SIGNATURE OF FIELD REPRESENTATIVE

20 I hereby request that any DIVIDEND payable under this policy applied for and be applied to the purchase of PAID UP ADDITIONS TO THE SUM INSURED UNTIL AND UNLESS ANY OTHER OPTION SHALL BE SELECTED IN ACCORDANCE WITH THE TERMS OF THE POLICY.

Figure 3. Sample Accounting and Application Data Sheets

A 1231/1232 can be programmed to recognize each part (field) of a data sheet on an individual basis. Each field can then be checked for the various conditions under which a document can be selected.

A Master Mark special feature provides group identification when several data sheets are to be processed as a group.

Data Sheet

The document used as input to the Optical Mark Page Readers is an 8 1/2" x 11" sheet of paper called a "data sheet". The data sheet contains a maximum of one thousand mark positions. The mark positions are arranged in as many as fifty rows, each row containing a maximum of twenty mark positions.

Each row is divided into two groups of ten mark positions each. The ten mark positions are called "words". Each word is divided into two groups of five mark positions called "segments". Consequently, each data sheet can have a maximum of 50 rows, 100 words, and 200 segments. A data sheet normally contains five rows per inch, but may have less.

Timing marks are printed along the right-hand edge of each data sheet. These marks are used to synchronize the motion of the document with the various units of the reader. Each word on the data sheet has an associated timing mark.

Words within each row of the data sheet are divided into two groups: odd-numbered words and even-numbered words. Odd words are on the left, even words on the right. The timing mark for an odd-numbered word is .636" above the mark positions of the word; the timing mark for an even-numbered word is .536" above the mark positions of the word.

Whenever a new data sheet is to be designed, three standard layout forms are available for use as design guides. Form X20-8043 is designed with five rows per vertical inch; Form X20-8044 is designed with four rows per inch; and Form X20-8045 is designed with three rows per inch. Any combination of these forms may be used as long as the timing mark relationship to the rows is maintained, and the rows are never printed closer than the minimum spacing of .200". Two timing marks should be printed for every row of words as these timing marks are used to trigger the read head activity from odd-word to even-word to odd-word, etc.

Input documents must adhere to specific dimensions and tolerances. When a new document is designed or ordered, document layout, paper, and ink requirements should be reviewed. Before large quantities of documents are ordered, a sample of the document should be sent to the nearest IBM Branch Office for review.

Data Sheet Terminology

Timing Mark: Rectangular marks preprinted on the data sheet in non-reflective ink. The timing mark is used to synchronize the motion of the document with the various units of the 1231/1232. Timing marks are located on the right-hand side of the data sheet (Figure 4).

Mark Positions: Areas printed in reflective ink that designate where marks are to be placed. A non-reflective mark in this area is read as a word or bit.

Words: Ten mark positions of a row. Words on the left half of the data sheet are odd words; words on the right half of the data sheet are even words.

Segments: Mark positions 0 through 4, or 5 through 9 of any word.

Non-Reflective Inks: A type of ink that is sensed by the 1231/1232. Usually, timing marks are the only non-reflective printing on the data sheet. The recommended non-reflective ink is black. See *Ink Requirements*.

Reflective Inks: A type of ink not sensed by the 1231/1232. Reflective inks are used for headings, data sheet instructions, mark position outlines and any other data that is not to be read.

Marking The Data Sheet

Marks that are to be read by an IBM 1231/1232 must be dark enough for positive machine-reading, yet erase easily and completely. For these reasons, a number 2 pencil is recommended.

Marks made with a number 1 pencil, or an IBM Electrographic pencil*, are difficult to erase; even after an erasure is made, a residue remains that could be read as a mark by the machine.

Erasures should always be made carefully and completely. Any incomplete erasure could be read as a mark.

When response positions are marked, the mark should be made the full length of the mark position, and should fill at least two-thirds of the space between the top and bottom of the guide lines. A mark that extends no more than 1/16" past the ends of the response position is acceptable in all but the last even-word position (next to the timing marks). In this position, a mark must not extend beyond the right end of the guide lines or it could be read as a timing mark. This would result in erroneous reading of the rest of the data sheet.

*Trademark

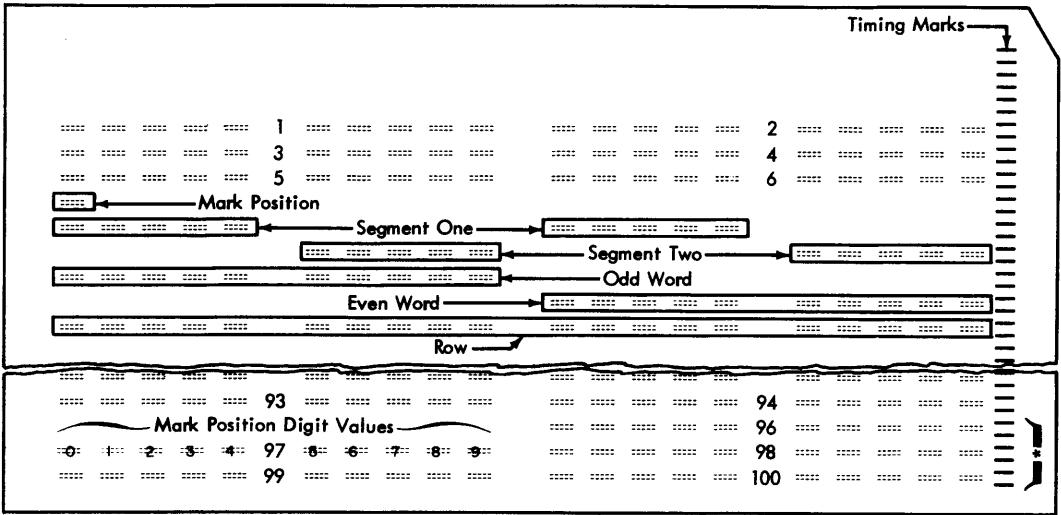

* These six control timing marks are used for counter read out controls in the IBM 1230.

Figure 4. Data Sheet Format

Principles Of Operation

The IBM Optical Mark Page Readers use sonic delay lines for storing controls and data. Controls are marked on the regular data sheet and entered into storage during the program load cycle. This data sheet is referred to as a program control sheet.

As data sheets are read, data is stored in the delay lines according to instructions from the program control sheet. Each word or segment to be stored must be programmed for entry into storage.

When a data sheet passes under the photo-electric read head, each word or segment is tested (according to preset switch settings) for conditions, such as; no-mark, multi-mark, or other-than-one. Any word or segment that does not pass the requirements of these switch settings causes the data sheet to be routed to the select stacker.

Storage data is available for readout to either a data processing system or to an IBM 534 Model 3 Card Punch. The cards punched in a 534 operation can be used as input to either a data processing system or a unit record machine.

Document Path

The data sheet begins its movement through the Optical Mark Page Reader when it is fed from the hopper. The document then passes under a read head; is transported through the transport area, past a selection station, and on into one of the two gravity stackers (Figure 5).

Feed Hopper

Data sheets are placed in the hopper (Figure 6) with the side to be read facing up; the top edge of the data sheet positioned to feed first. Data sheets feed from the top of the stack. The platform on which the documents are held raises automatically to maintain proper feeding. Whenever documents are added to the hopper, document feeding must be discontinued and the platform lowered to accommodate the additional supply of documents. If the stop key is pressed or any emergency stop switch activity occurs, the document platform drops immediately. The stop key stops only the feeding of the documents. An emergency stop (jam, misfeed, timing mark check, etc.) halts the feed rolls, as well as document feeding.

The capacity of the hopper is approximately 600 documents. When documents are processed at the rate of 2,000 per hour, the hopper capacity is great enough for 18 minutes of continuous operation without operator attention. If feeding is attempted and for some reason,

such as an empty hopper, a document is not fed within five seconds, the entire feed unit stops operating and the hopper platform drops.

Feed and Transport Mechanism

The feed unit of an Optical Mark Page Reader contains a set of four picker belts, two restraint belts, and a separator roll. The transport area contains the feed rolls. As the feed rolls move a document through the transport area, the document passes a selector station and moves on into either the normal or select stacker.

A depression of the reset key brings documents up to the feeding level and starts feed roll and restraint belt activity. When the start key is pressed, picker belt and drive roll activity starts. Picker belts and the separator roll are operated by the picker belt clutch. The picker belts ride on top of the stack of documents in the hopper, and move documents into the separator station.

At the separator station, a drive roller acts upon the top document to move it forward, while restraint belts move the balance of the documents backward. This creates a shearing action, causing separation of documents. The top document feeds, and the lower documents are restrained. The restraint belts move at a slower speed and have a lesser effect on documents than the drive roller. Therefore, whenever both the drive roller and the restraint belts act upon the same document, the document continues to move forward.

The first set of feed rolls is located about one and one-half inches ahead of the leading edges of the documents in the hopper. A document sensing device, just under the first top roll, senses the presence of documents. As documents pass, they are recognized by this sensing device, causing the picker belts and drive roll to stop. When the trailing edge of the document passes the sensing device, circuits are activated which cause another feed cycle. Consequently, if the feed mode switch (1231) is set for continuous feeding, documents feed approximately one and one-half inches apart.

When the 1232 is operating with the IBM 534 Model 3 Card Punch, documents feed as just described, but are controlled by the program card in the 534. The picker belts do not operate until two conditions are satisfied: (1) the 534 has issued a feed call, and (2) the previous document has passed the document sensing device in the 1232.

All documents pass the read station as they move through the transport mechanism. By the time the leading edge of a document has reached the drive rolls just ahead of the selector station, all reading has been com-

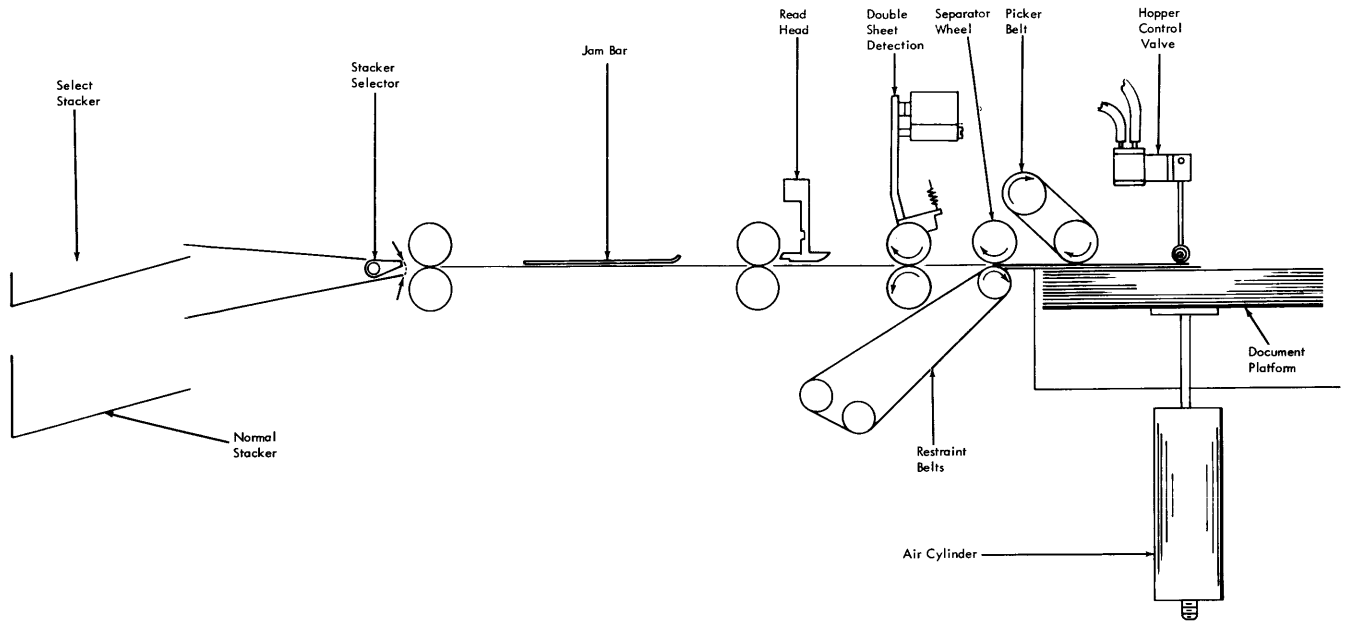

Figure 5. Document Path

pleted. Drive rolls beyond the read station accelerate the document to ensure proper stacking.

Selector Station and Stackers

An Optical Mark Page Reader has two stackers, Normal and Select, into which it can direct documents (Figure 7).

The normal stacker holds about 600 documents. The select stacker, which is just above the normal stacker, holds about 50 documents. Both stackers are equipped with full-stacker switches that stop document feeding when either stacker is filled.

As soon as a document passes the read station, the reader examines its logic and machine controls to determine into which stacker the document will be directed. Documents always enter the normal stacker unless con-

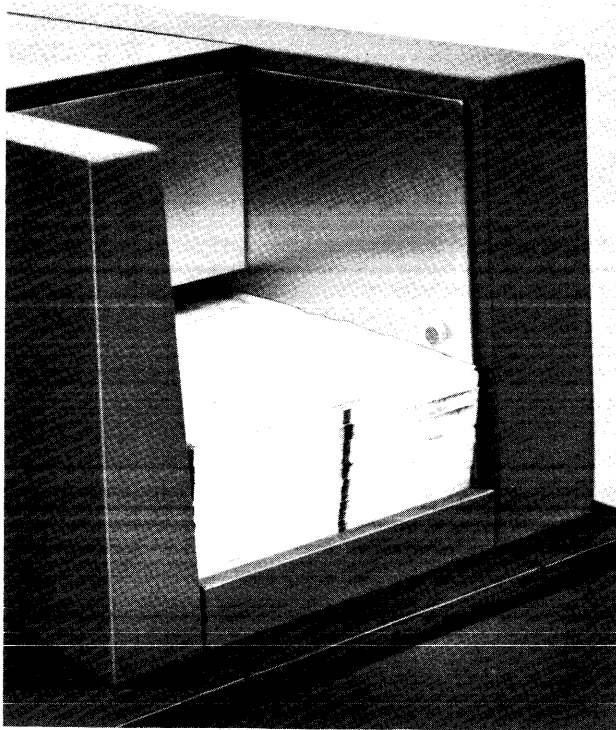

Figure 6. Feed Hopper

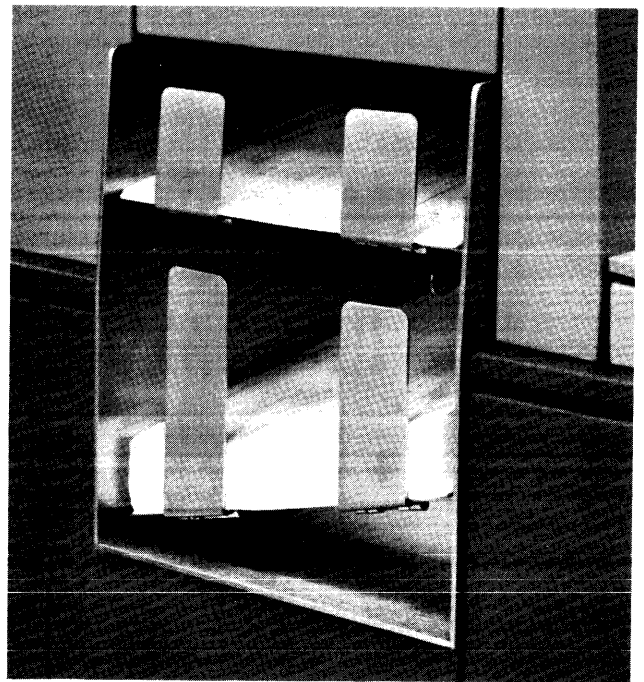

Figure 7. Stacker

trolled to enter the select stacker. If a document is to be selected, a selector guide in the selector station deflects the document into the select stacker.

The processing unit can also control the direction of a document into the select stacker if a 1231 is being used. After the document has been read, the processing unit has 50 ms in which to analyze the data and give the select instruction.

Reading

“Reading” is a term applied to the recognition of data, and its conversion into machine-usable language. The IBM Optical Mark Page Reader recognizes data by means of changes in current at the read head.

Read Unit

The read unit of a fully-equipped Optical Mark Page Reader contains 22 photovoltaic cells. Twenty of these cells are used for reading data from the document, one is used for reading the timing marks, and one is used for recognition of a master mark (special feature).

Each photocell has an associated light source and light-limiting aperture. As documents pass under the read unit, light is directed onto the paper from these individual lamps, and reflects onto the exposed surface of their associated photocells. The intensity of the light striking the photocell is less when reflected from a marked position than when reflected from an unmarked position.

Photocells respond to light by producing current in measurable values; the more light striking a cell, the higher the current value. The Optical Mark Page Reader recognizes a current value substantially lower than normal as an indication that a mark is directly under the photocell. In order to assure that the Optical Mark Page Reader is reading valid marks only, outputs from the photocell are sampled only when mark positions on the document are properly positioned under the read unit (Figure 8).

The timing marks are read by the timing-mark photocell. When the first timing mark is read, the read cells for the first word are activated. As the data sheet moves on, the second timing mark is recognized and the second word is read. The timing marks synchronize the read cells with the word to be read.

As the data sheet moves through the read station, the timing marks cause the read cells to “flip-flop” from odd word to even word, etc. Because of the vital functions performed by the timing marks, extraneous marks must not be marked or printed in the timing-mark area.

Under control of the timing marks, words are read from left to right, from top to bottom, row by row. Two timing marks are associated with each row (one for each word). The first timing mark (upper) activates

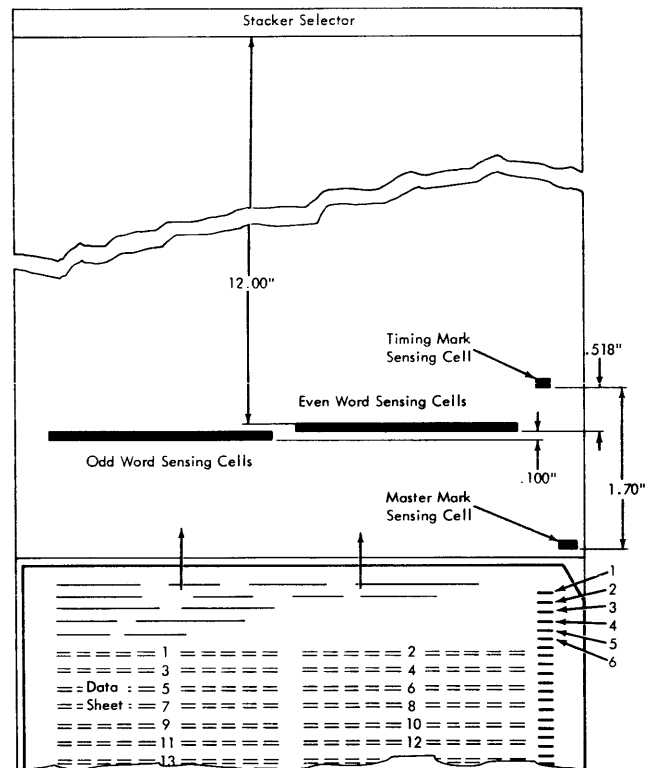

Figure 8. Reading Schematic

the left word; the second timing mark activates the right word.

Although the timing marks determine which read cells are active, final storage of data from each word is controlled by the program control sheet. See *Program Control Sheet*.

A timing-mark-counting feature enables the 1231/1232 to detect missing or extra timing marks. Counting of the timing marks assures that the entire data sheet was scanned correctly. Stray marks in the timing mark area, or a folded corner on a sheet, can be detected.

When a timing-mark check is to be made, the 11-position (0 through 9, and OFF) rotary switch, on the operators' control panel, must be preset to the units-position count of the timing marks on the data sheet. (When a timing mark check is not desired, the switch should be set to OFF.) If there were 106 timing marks on each data sheet, the rotary switch would be set to “6”. Then, a units-position count of other than 6 would cause the machine to stop and the process-check light to turn on.

Mark Recognition and Discrimination

During the reading of data sheets, the Optical Mark Page Readers categorize marks according to their degree of light reflectance (Figure 9). A mark falls into one of

the following categories:

1. Good
2. Poor
3. Uncertain

A good mark is recognized as a positive indication of a mark; a poor mark (or good erasure) is not recog-

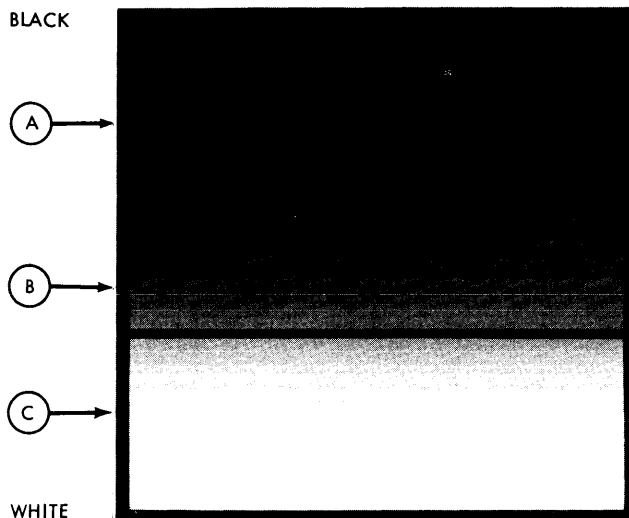

A: Good Mark
 B: Light Mark or Poor Erasure
 C: Poor Mark or Good Erasure (Marks in this area are not read)

Figure 9. Mark Reflectance Relationship

nized as a mark, and an uncertain mark (light mark or poor erasure) is one whose light reflectance level comes somewhere in between a good mark and a poor mark, but cannot be positively identified as either. The reading or rejection of uncertainties can be customer-controlled.

Three read-mode switches, each associated with a set of field-checking switches, allow operator-control of mark discrimination on a field-by-field basis. Documents containing uncertainties can be selected for a visual check if desired.

Each of the three read-mode switches has four settings: SING RESP (single response); MULT RESP (multiple response); SING RESP SEL UNC (single response select uncertainties), and MULT RESP SEL UNC (multiple response select uncertainties).

The setting of each read-mode switch affects mark discrimination (Figure 9) as follows:

1. SING RESP:
 - a. Marks in area A are accepted.
 - b. Marks in area B that are not accompanied by a mark in Area A of the same word or segment are accepted.*
 - c. Marks in area B that are accompanied by a mark or marks in area A of the same word or segment are not accepted.*

2. SING RESP SEL UNC:
 - a. Marks in area A are accepted.
 - b. Marks in area B that are not accompanied by a mark in area A of the same word or segment cause the data sheet to be selected.*
 - c. Marks in area B that are accompanied by a mark in area A of the same word or segment are not accepted as marks.*
3. MULT RESP:
 - a. Marks in area A are accepted.
 - b. Marks in area B are accepted.
4. MULT RESP SEL UNC:
 - a. Marks in area A are accepted.
 - b. Marks in area B cause the document to be selected.

Whenever a data sheet is selected by the 1231, storage is cleared and data from that data sheet is not transferred to the computer. However, in the 1232, the information is transferred to the 534 Card Punch and a card is punched. The word or segment in which the uncertainty is detected is transferred to the card punch as a blank character, and the 11-punch in column 81 is inhibited.

Data Flow

The entry of data, control bits, and master data into the IBM Optical Mark Page Readers depends upon whether the reader is a 1231 or a 1232. The differences result because of the storage units used, the internal transfer of the data, and the storage used as output to the processing system or to the IBM 534 Model 3 Card Punch.

IBM 1231 Data Flow

Before the 1231 can act as an input device to a data processing system, the controls for the internal functions must be loaded and switches must be set to establish the conditions required for the particular run.

Two storage devices (sonic delay lines) are used to store and control the data as it is read from the data sheets. One of these storage devices, the "master" line, is used to store all the controls from the program control sheet and, if the 1231 is equipped with the Master Mark special feature, master-mark data and controls associated with master-mark data are also stored.

The other storage line, the "data" line, is used to store information from the data sheet. As the data sheet is read, the two storage lines work concurrently and in synchronism. The master line, which contains the program instructions, determines which information from the data sheet is to be retained.

*The number of mark positions included in any one mark discrimination test is determined by the setting (SEGMENT or WORD) of the check-length switch.

The following sequence is used for entering data into a fully equipped 1231, and for making this information available to the processing system (Figure 10):

1. Line mark and word mark bits are generated by internal circuitry to establish the starting point of the data on the delay lines. These bits go into the data delay line.
2. Program control bits are loaded into the 1231 from the program control sheet, and go into the master line.
3. Master-mark information (if Master Mark special feature is installed and being used) is entered into the first ten positions of the master line.
4. Detail data reads into positions 12 through 111 of the data line.
5. A READ instruction from the processing unit causes the data (master and detail) from the master line and the data line to read out in sequence into the A register. The master data from positions 1 through 10 of the master line reads out first, followed by positions 12 through 111 of the data line.

The master and data lines read into the A register one segment at a time. Data is transferred from the A register to the B register between segments. While data is transferring from the B register to the processing system, the A register is receiving data from the next segment in storage. As data is transferred from the delay lines to the A register, each character is checked for odd-parity.

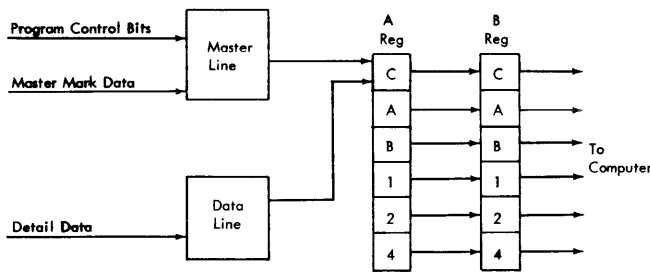

Figure 10. IBM 1231 Data Flow

IBM 1231 Message Format

Each word transferred from the 1231 to the computer reads into two adjacent positions of computer storage. Words are transferred one segment at a time; each segment entering one computer storage position. Words with marks in positions 0, 1, 2, 3, or 4 transfer to the computer as A, B, 1, 2, or 4 bits. Combinations of these bits make up a valid character. Similarly, marks in positions 5, 6, 7, 8, or 9 transfer to the computer as A, B, 1, 2, or 4 bits. Any or all of the marking positions on the data sheet may contain marks, and the data will

be transferred to the computer as a valid combination of bits.

NOTE: When a zero or a five is the only mark read within a segment, the mark is transferred to the computer as an A-bit only. If the mark is then written onto a tape instructed to write in even-parity, the A-bit is combined with a C-bit. This combination represents a substitute blank character when read out of the tape to the computer. The original mark on the data sheet has lost its identity. If the A-bit is first translated into some normal core storage character (i.e. an 8-2 for a numeric zero) before writing it onto tape, its identity is retained. Also, if the tape unit is instructed to write in odd-parity, each character transferred from the 1231 will retain its original core storage identity.

Data is read by the 1231 from left to right, top to bottom, a row at a time. Information from a data sheet is stored in the following sequence:

1. Segment one of the first word programmed to read.
2. Segment two of the first word.
3. Segment one of the second word programmed to read.
4. Segment two of the second word.

If only one segment of any word is programmed to read, only one position of computer storage is used.

IBM 1232 Data Flow

The 1232, when used with an IBM 534 Model 3 Card Punch, uses the facilities of both units for controlling information as it is entered, transferred, and made available to the 534.

Program control bits are entered into the 1232 storage from a program control sheet. Master data, to be retained until the next master data sheet is read, is entered into the first ten positions of storage. Detail data enters storage in positions 11 through 110.

In a fully equipped 1232, the following sequence is used in entering the program controls, master data, and detail data into the machine (Figure 11).

1. Line Mark and Word Mark bits are generated by internal circuitry.
2. Program controls are loaded into storage delay lines 1 and 2.
3. Master data is read into delay line 1 (first 10 positions).
4. Detail data is read into delay line 1 (positions 11 through 110).
5. Controlled by the 534 program card, master and detail data are read from line 1.

Data and control bits are checked for even parity as they transfer from the delay line to the punch register.

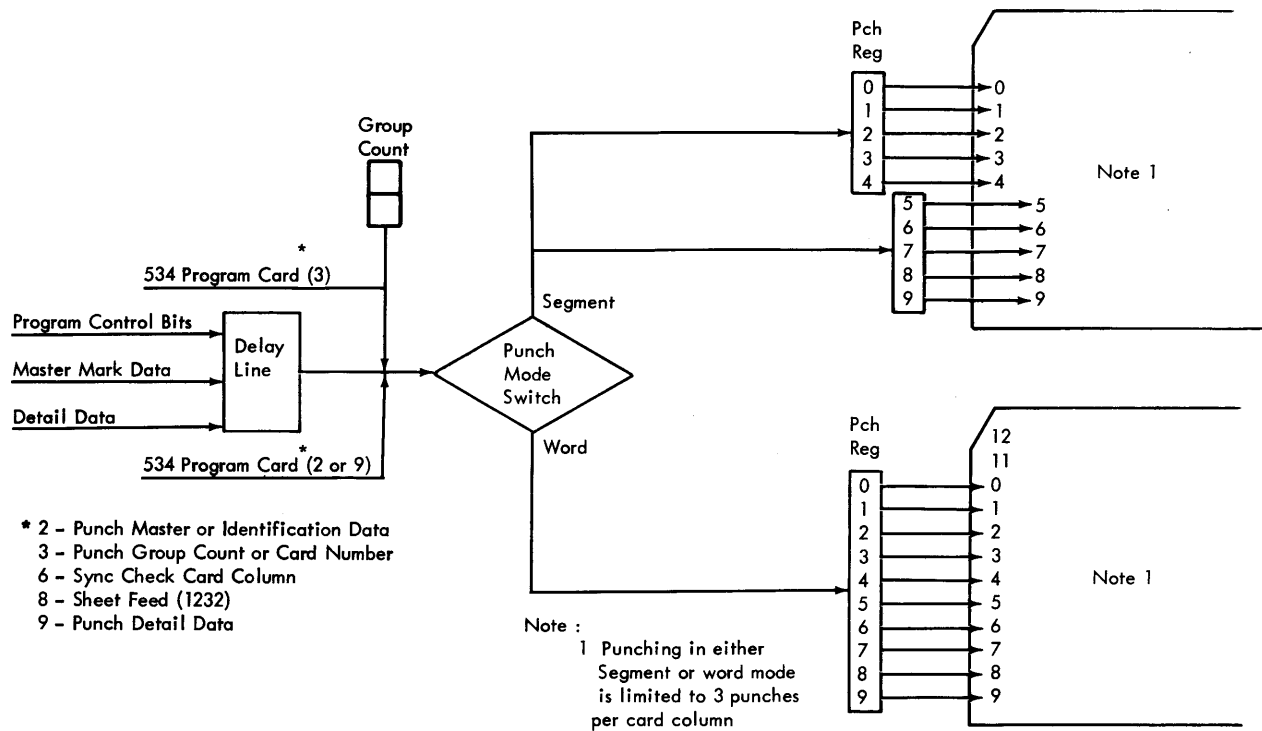

Figure 11. IBM 1232 Data Flow, Including Segmented Word Feature

IBM 1232 Message Format

Each word transferred from the 1232 to the 534 transfers digit-value-for-digit-value. A 9-mark in a word on the data sheet would transfer and punch as a 9-punch in the card; a 3-mark and a 7-mark in one word would transfer and punch as a 3-punch and a 7-punch in one card column (when the 1232 is operating in word mode). When multiple punches in the card are not a standard card code, a special feature may be required on the using system. For example, the Column Binary special feature is required for 1401 processing; the Card Image special feature is required for 1440 processing.

The data sheet is read from left to right, top to bottom, one row at a time. All like data (identification or detail data) will transfer to the 534 Card Punch in the sequence read. If the first ten odd-words on the data sheet were identification data (*available only on machines equipped with either the Multiple Spread-Card or Unit Record Card feature*) and the first ten even words were detail data, the data would be stored in alternate positions as read. In this case, the first word in storage would be identification data, the second word would be detail data, etc. When the data is called for by the 534 (a 9 punch calls for detail data, a 2 punch calls for identification data), like data would read out of 1232 storage as it was read. If identification data were called for in the first ten positions of the 534 program card, only the odd words (1 through

19) would read out and punch. Even words 2 through 20 would read out and punch when detail data is requested by the 534 program card. If a word on the data sheet is not marked but the program control sheet calls for reading of the unmarked word, the associated card column is spaced over.

IBM 1232/534 Synchronization Check

Words that are read by the 1232 must be punched in the correct card columns by the 534. This synchronization is accomplished through the programming of both machines. Two programming procedures are involved; the marking of the program control sheet used in the 1232, and the punching of the program card associated with the 534.

When the 1232 program control sheet is marked, a mark in position 4 and a mark in position 8 designates the word as a sync-check word.

When the 534 program card is punched, a 6-punch and a 9-punch in a card column designates a sync-check card column. Failure to match the sync-check word with the sync-check card column causes the machine to stop and the punch-check light to turn on.

To maintain maximum sync-checking on each card, the sync-check card column should be the last column of detail data programmed to punch. However, because a sheet-feed instruction can be programmed (534 program card) as many as eight columns ahead of the last

column of data to be punched, a sync check could occur either before or after a feed instruction.

A sync check *before* a feed instruction requires the reprocessing of only the last document read. A sync check *after* a feed instruction requires reprocessing of two documents: the last one stacked, and that in the 1232 transport.

When synchronization check is used with either the Multiple Spread-Card or the Unit Record Card features, sync-check words in the 1232 must be programmed to correspond to the last column punched in each card. Then, the sync-check words and the sync-check card columns will match when multiple cards are punched for a data sheet.

When punching is in segment mode (Segmented Word feature) the two card columns that correspond to the two segments of the sync-check word must be programmed as sync-check columns. However; when only one segment of the word is to be punched, only one sync-check card column is needed.

Field Checking

The field-checking feature, standard on both the 1231 and 1232, allows each word programmed to read to be checked for mark conditions which may indicate invalid data. Three switch-controllable mark conditions, each of which will cause the document to be selected, can be checked. These conditions are: Multi-marks, No marks, and Other-Than-One. The switch also has an "off" position.

Data sheets are usually designed with "fields" of similar data in vertically consecutive words on the left or right sides of the data sheet. The policy number field, shown in Figure 12, is an example of a *data sheet field*.

A *field-checking field* differs from a data sheet field primarily in functional grouping. A data sheet field groups similar information for ease of marking and reference. A field-checking field may contain part of, or several data sheet fields. The primary requirement of field checking is that all mark data within a field's area of coverage be checked for the same conditions (multi-mark, no mark, etc).

The field-checking fields on the data sheet are defined by special codes (start-of-checking codes) which are entered into 1231/1232 storage from the program control sheet. A field-checking field can be from one to one hundred words in length.

Three start-of-checking control codes allow any specific area of the data sheet to be checked according to one of three groups of field-checking switches. The three groups of field-checking switches are labelled; Field I, Field II, and Field III.

The checking of a field-checking field by a particular group of switches begins on the word in which the field-

checking control code is recognized. On the program control sheet, a mark in position SIX designates the start of data checking according to conditions set up in Field I switches; a mark in position SEVEN designates the start of data checking according to conditions set up in Field II switches; marks in positions SIX AND SEVEN designate the start of data checking according to Field III switches.

A new data sheet always starts checking according to Field I switches unless programmed otherwise. Figure 13 shows the program controls needed to read and field check the illustrated insurance form. The setting of the switches is shown in Figure 12.

Three switches are assigned to each field: (1) a read mode switch, which determines how uncertainty marks are handled; (2) a check length switch, which determines whether information is to be checked on a word or segment basis; and (3) a select condition switch, which determines the conditions for which a data sheet will be selected.

Because the data sheet is read from left to right, top to bottom, row by row, field checking becomes an important factor when a new data sheet is to be designed. If, for instance, the data sheet is to be used for a "yes" and "no" survey, the yes and no mark positions should be within one segment or word in order to allow checking for both, either, or neither answer.

The field checking feature can be summarized as follows:

- Each of the three field-checking switches can be set to one of the select conditions, or to the OFF position.
- Unless programmed for another field, checking always returns to Field I at the start of a new data sheet.
- Field checking by a given set of field-checking switches begins in the word programmed and continues (in all words programmed to read) until a new field checking command has been recognized.
- A field can begin or end on either the left or the right word.
- A field can be from one to one hundred words in length.
- Three conditions can be checked: OTHER-THAN-ONE (multi-mark and/or blank detection), NO-MARK (blank detection only), and MULTI-MARK (multi-mark detection only).

When a data sheet is selected because of a field-checking condition, or because of an uncertainty reading, the 1231 does not transmit any data from that data sheet to the computer. The 1232, under the same conditions, allows the card to be punched, omitting the punch from the position in which the uncertainty was read. The 11-punch in column 81 is also omitted from that card.

Figure 12. Field Checking Boundaries and Switch Setup (Sample Form)

ANY LIFE INSURANCE COMPANY
INDUSTRIAL APPLICATION

DATE OF POLICY		POLICY NUMBER		POLICY NUMBER			
1. Your FULL NAME (Print)				FIELD I			
(FULL FIRST NAME)		(MIDDLE INITIAL)					
2. RESIDENCE (Print) NO. STREET				FIELD II			
CITY OR TOWN		ZONE	STATE	FIELD II			
3. Place of Birth (STATE)		4. DATE OF BIRTH		5. AGE LAST Birthday		FIELD II	
		MONTH	DAY	YEAR	Years		
6. Married		Widowed		Single		FIELD II	
7. What is your height and weight? ft. ins. lbs.				13. BENEFICIARY (Print FULL NAME)			
8. Do you now have insurance with the ANY LIFE INSURANCE COMPANY?				AGE			
YES				NO			
IF YES, WHICH?				RELATIONSHIP OF BENEFICIARY			
9. POLICY APPLIED FOR		FACE AMOUNT PURCHASE		FIELD III			
(a) PLAN				FIELD III			
..... WL 75	 \$50		FIELD III			
..... WL 85	 \$200		FIELD III			
..... IOPL	 \$1000		FIELD III			
..... ISPL				FIELD III			
10. (a) OCCUPATION, Job title, and nature of work performed.				FIELD II			
If job title appears below check mark if otherwise complete Questions I				FIELD II			
on back.				FIELD II			
(a) Job title				FIELD II			
HOUSEWIFE STUDENT				FIELD II			
II. PREMIUM PAYABLE				FIELD II			
MONTHLY		QUARTERLY		SEM-ANNUAL		ANNUAL	
12. CLASSIFICATION				FIELD I			
STANDARD		RATING 1		RATING 3		OTHER SPECIFY ON BACK	
A G E				FIELD I			
0		1		2		3	
H E I G H T				FIELD I			
0		1		2		3	
W E I G H T				FIELD I			
0		1		2		3	
19. REPORT OF FIELD REPRESENTATIVE				FIELD I			
Have you checked above application to make sure all items and				FIELD I			
questions are answered?				FIELD I			
Do you certify that all information contained on this REPORT				FIELD I			
OF FIELD REPRESENTATIVE is a true and correct copy of				FIELD I			
information which appears on application?				FIELD I			
SIGNATURE OF				FIELD I			
FIELD REPRESENTATIVE				FIELD I			
20. I hereby request that any DIVIDENDS payable under the policy applied for				FIELD I			
UNTIL AND UNLESS ANY OTHER OPTION SHALL BE SELECTED IN A				FIELD I			
The foregoing statements and answers are true and complete				FIELD I			
of the contract of insurance if one is issued; (2) no agent or any other				FIELD I			
behalf of the Company (a) to make, modify or discharge any contract,				FIELD I			
respecting any benefits under any policy issued hereunder; (3) the Company will incur no liability by reason of this application except as may be				FIELD I			
provided in a Conditional Receipt given on and bearing the same date as this application, until a policy has been delivered and the full first				FIELD I			
premium has been paid to the Company.				FIELD I			
Amount paid in advance on account of		Dated at		FIELD I			
		this		FIELD I			
		day of		FIELD I			
First Premium \$		Signature of Applicant		FIELD I			
				FIELD I			
which does		does not		FIELD I			
represent full first premium		Signature of Witness		FIELD I			
				FIELD I			

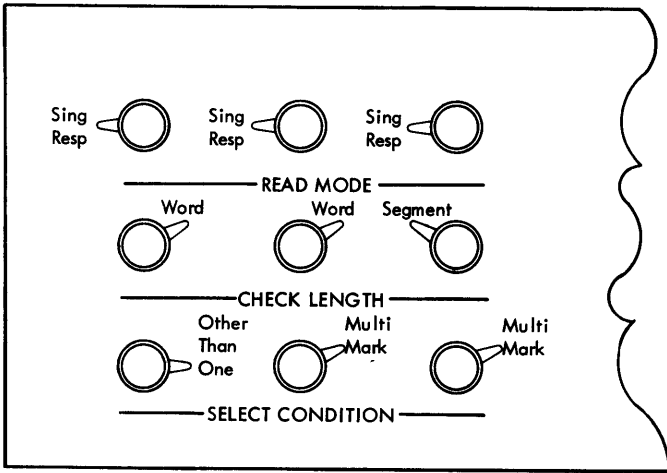

FIELD I SETUP
 Read Mode Switch---Set to Sing Resp
 Check Length Switch---Set to Word
 Select Condition Switch---Set to Other-Than-One

FIELD II SETUP
 Read Mode Switch---Set to Sing Resp
 Check Length Switch---Set to Word
 Select Condition Switch---Set to Multi-Mark

FIELD III SETUP
 Read Mode Switch---Set to Sing Resp
 Check Length Switch---Set to Segment
 Select Condition Switch---Set to Multi-Mark

ANY LIFE INSURANCE COMPANY
INDUSTRIAL APPLICATION

DATE OF POLICY		POLICY NUMBER	
1 Your FULL NAME (Print)		P O L I C Y	
(FULL FIRST NAME) (LAST NAME)		L I C E	
2 RESIDENCE (Print) NO STREET		C O U N T Y	
CITY OR TOWN		N O	
3 Place of Birth (STATE)		U N I T	
4 DATE OF BIRTH MONTH DAY YEAR		M O N T H	
5 AGE LAST BIRTHDAY		A G E	
6 Married Widowed Single		B E R	
7 What is your occupation?		R	
8 Do you now have insurance with the ANY LIFE INSURANCE COMPANY?		A S E	
IF YES, WHICH?			
9 POLICY APPLIED FOR (a) PLAN		13 BENEFICIARY (Print FULL NAME)	
Wife \$250 \$500 \$750 \$1000		HUSBAND MOTHER FATHER SON	
E80 \$25 \$50 \$75		WIFE MOTHER FATHER SON	
E80 \$50 \$100 \$200		DAUGHTER CHILD BROTHER SISTER	
E80 \$100 \$200 \$500		NEPHEW NIECE OTHER SPECIFY ON BACK	
E80 \$200 \$500 \$1000		15 Have you in the past five years consulted a doctor for a serious disease, injury, disability, or other condition, or have you had a major bone fracture and such consultation resulted in treatment which exceeded a period of one week?	
E80 \$500 \$1000		YES NO	
E80 \$1000		16 Have you any physical defect or impairment of health?	
E80 \$1000		YES NO	
10 (a) OCCUPATION, job title, and nature of work performed. If job title appears below check mark if otherwise complete questions (b), (c), and (d).		17 Within the last five years have you been declined, postponed, or offered a policy other than that applied for by this or any other company?	
HOUSEWIFE STUDENT CLERK UNEMPLOYED		IF YES, explain on back. YES NO	
11 PREMIUM PAYABLE (a) Job title (b) Name of Present Employer (c) Business address		18 Does applicant reside in some state in which district office is located?	
MONTHLY QUARTERLY SEM-ANNUAL ANNUAL		YES NO	
12 CLASSIFICATION STANDARD RATING RATING 3 OTHER SPECIFY ON BACK		19 Have you checked above application to make sure all items and questions are answered?	
A 1 2 3 4 TENS 5 6 7 8 9		DO YOU CERTIFY THAT ALL INFORMATION CONTAINED ON THIS REPORT OF FIELD REPRESENTATIVE IS A TRUE AND CORRECT COPY OF INFORMATION WHICH APPEARS ON APPLICATION?	
E 0 1 2 3 4 UNITS 5 6 7 8 9		YES NO	
E 1 2 3 4 UNITS 5 6 7 8 9		SIGNATURE OF FIELD REPRESENTATIVE	
E 2 3 4 UNITS 5 6 7 8 9		14	
E 3 4 UNITS 5 6 7 8 9		100'S	
E 4 UNITS 5 6 7 8 9		10'S	
E 5 UNITS 6 7 8 9		1'S	
E 6 UNITS 7 8 9		CENTS	
E 7 UNITS 8 9		MILLICENTS	
E 8 UNITS 9		MICROCENTS	
E 9 UNITS		NANOCENTS	
E 10 UNITS		PICOCENTS	
E 11 UNITS		FEMTOCENTS	
E 12 UNITS		ATTOCENTS	
E 13 UNITS		SEPTOCENTS	
E 14 UNITS		OCTOCENTS	
E 15 UNITS		NONOCENTS	
E 16 UNITS		DECI-CENTS	
E 17 UNITS		CENTS	
E 18 UNITS		MILLICENTS	
E 19 UNITS		MICROCENTS	
E 20 UNITS		NANOCENTS	
E 21 UNITS		PICOCENTS	
E 22 UNITS		FEMTOCENTS	
E 23 UNITS		ATTOCENTS	
E 24 UNITS		SEPTOCENTS	
E 25 UNITS		OCTOCENTS	
E 26 UNITS		NONOCENTS	
E 27 UNITS		DECI-CENTS	
E 28 UNITS		CENTS	
E 29 UNITS		MILLICENTS	
E 30 UNITS		MICROCENTS	
E 31 UNITS		NANOCENTS	
E 32 UNITS		PICOCENTS	
E 33 UNITS		FEMTOCENTS	
E 34 UNITS		ATTOCENTS	
E 35 UNITS		SEPTOCENTS	
E 36 UNITS		OCTOCENTS	
E 37 UNITS		NONOCENTS	
E 38 UNITS		DECI-CENTS	
E 39 UNITS		CENTS	
E 40 UNITS		MILLICENTS	
E 41 UNITS		MICROCENTS	
E 42 UNITS		NANOCENTS	
E 43 UNITS		PICOCENTS	
E 44 UNITS		FEMTOCENTS	
E 45 UNITS		ATTOCENTS	
E 46 UNITS		SEPTOCENTS	
E 47 UNITS		OCTOCENTS	
E 48 UNITS		NONOCENTS	
E 49 UNITS		DECI-CENTS	
E 50 UNITS		CENTS	

PROGRAM CONTROLS ILLUSTRATED

- Mark in position 8--Read word.
- Marks in positions 6 and 8--Read word and check data according to Field I switch setup.
- Marks in positions 7 and 8--Read word and check data according to Field II switches.
- Marks in positions 6, 7, and 8--Read word and check data according to Field III switch setup.
- Marks in positions 4 and 8--Read word. The 4 designates a sync-check word for 1232 use with the IBM 534 Card Punch.

PROGRAM CONTROLS NOT ILLUSTRATED

- Marks in positions 0 and 8--Read segment one of the word so marked.
- Marks in positions 5 and 8--Read segment two of the word so marked.
- Marks in positions 3 and 8--Read and store this word as identification data. This program control is used with either the Multiple Spread-Card or Unit Record Card features on the 1232 only.
- Marks in positions 1 and 8--Reads the word and indicates the end of a group to advance the group count (Unit Record Card feature--1232 Only)

Figure 13. Program Control Sheet for Reading and Field Checking (Sample Form)

Alphabetic Coding

An alphabetic coding capability is necessary and desirable in many applications. Three methods of alphabetic coding are illustrated in Figure 14.

Scheme 1: To code an alphabetic character, a mark must appear in the appropriate marking position of both the odd (left hand) and even (right hand) words of the same horizontal row. For example; to indicate the letter K, one mark must be made in the marking position immediately below the caption "J thru R" in the odd word, and one mark must be made in the marking position immediately below the caption "BKS" in the even word of the same horizontal row.

The odd-word, in this scheme, represents the zone portion of the character. In 1232/534 application, two card columns will be used for each alphabetic character marked. Marks in positions 0 through 9 of each word will punch as 0 through 9 punches, the same as normal numeric punching.

Scheme 2: Each letter of the alphabet can be preprinted on the data sheet in reflective ink. The letters and/or numbers may be printed above, on, or below the mark positions. In this approach, the identity of each character is determined by its position in the matrix, which is programmable.

The entering of the marks is simple; however, considerable space is required on the data sheet to represent all the alphabetic and numeric characters. Four card columns are needed to represent all the alphabetic and numeric characters. An "A" would punch as a "1" in the first of the four columns; a "Y" would punch as an "8" in the third column.

Scheme 3: Each letter of the alphabet, or digits 0 through 9, can be represented by using only one word. An alphabetic character must be represented by a mark in each segment of the word selected for this purpose ("Z" is an exception). To indicate a "K", marks in the 2 position of the left-hand segment and in the 5 position of the right-hand segment are required. Each character is represented by a unique combination of punches.

For instance; suppose an "A" is marked in positions 0 and 5 of a word. If punching is on a word basis, the "A" would be represented by punches in positions 0 and 5 in a card column; the letter "X" would punch as a 4 and 8 in the corresponding card column.

Controls

The operator's console (Figure 15) on the Optical Mark Page Reader contains the keys, lights and switches necessary for setup and operation.

A thru I	J thru R	S thru Z	zero	AJ 1	BKS 2	CLT 3	DMU 4	ENV 5	FOV 6	GPX 7	HQY 8	IRZ 9	
----	----	----	----	----	----	----	----	----	----	----	----	----	
----	----	----	----	----	----	----	----	----	----	----	----	----	
----	----	----	----	----	----	----	----	----	----	----	----	----	
SCHEME I				For Alphabetic - Make two marks per horizontal row. For Numeric - Make one mark in the appropriate right hand (even) word.									
				Mark the Appropriate Position									
				::A::	::B::	::C::	::D::	::E::	::F::	::G::	::H::	::I::	
SCHEME II				::J::	::K::	::L::	::M::	::N::	::O::	::P::	::Q::	::R::	
				::S::	::T::	::U::	::V::	::W::	::X::	::Y::	::Z::		
				::0::	::1::	::2::	::3::	::4::	::5::	::6::	::7::	::8::	
				::9::									
				For Alphabetic - Make two marks per word. For Numeric - Make one mark per word.									
				ABC	FGH	KLM	PQR	UVW	AFK	BGL	CHM	DIN	EJO
				DE	IJ	NO	STZ	XYZ	PU	QV	RW	SX	TY
				0	1	2	3	4	5	6	7	8	9
SCHEME III				----	----	----	----	----	----	----	----	----	----
				----	----	----	----	----	----	----	----	----	----
				----	----	----	----	----	----	----	----	----	----

Figure 14. Alphabetic Coding Schemes

Keys and Switches

Start Key: A depression of the start key feeds the first data sheet and establishes continuous running conditions with two exceptions: (1) If the feed mode switch on the 1231 is set to CONTINUOUS, the feed circuits are interlocked with the program of the processing system and will not feed the first sheet until the processing system is placed in an operating status, and (2) if the Reader is in a load program cycle, the program control sheet feeds and the control bits are stored.

Stop Key: A depression of the stop key halts document feeding and lowers the hopper plate to facilitate the loading of more data sheets.

Reset Key: A depression of the reset key raises the hopper to the feed position and resets the electronic circuitry. Check or error conditions should be corrected before pressing the reset key.

Program Load Key: A depression of the program load key clears the delay line storage of previously-stored data, and conditions the machine for program load-

ing. This key is lighted during the program load cycle.

Master Mark Switch: The master mark switch is active only on machines equipped with the Master Mark special feature. This switch controls the capability of the Optical Mark Page Reader to recognize a master mark on the right edge of the data sheet. When this switch is on, the recognition of a master mark causes the data in the first ten positions of storage to be cleared and new master-mark data to be accepted.

Feed Mode Switch: The feed mode switch (1231 machines only) has two settings: CONTINUOUS and ON-DEMAND. When the switch is set to CONTINUOUS, documents feed continuously. This setting requires the processing unit program to give a read instruction within 150ms after buffer full in the 1231. Buffer full can occur as frequently as once every 1585 ms. When the switch is set to ON-DEMAND, feeding is controlled from the system program. The next document will not feed until the contents of the delay line (from the previous document) is transferred to the computer.

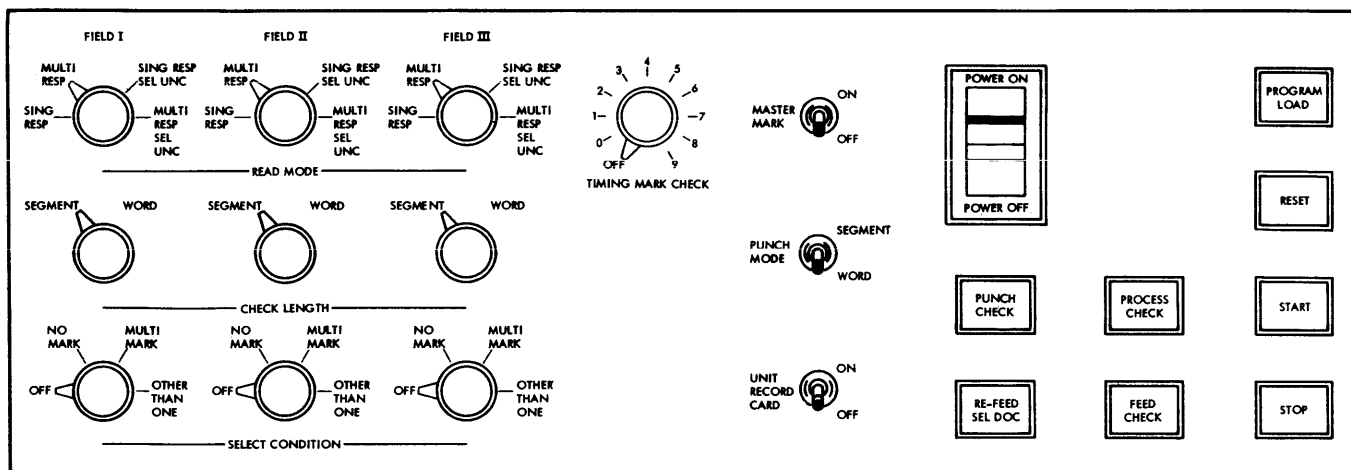
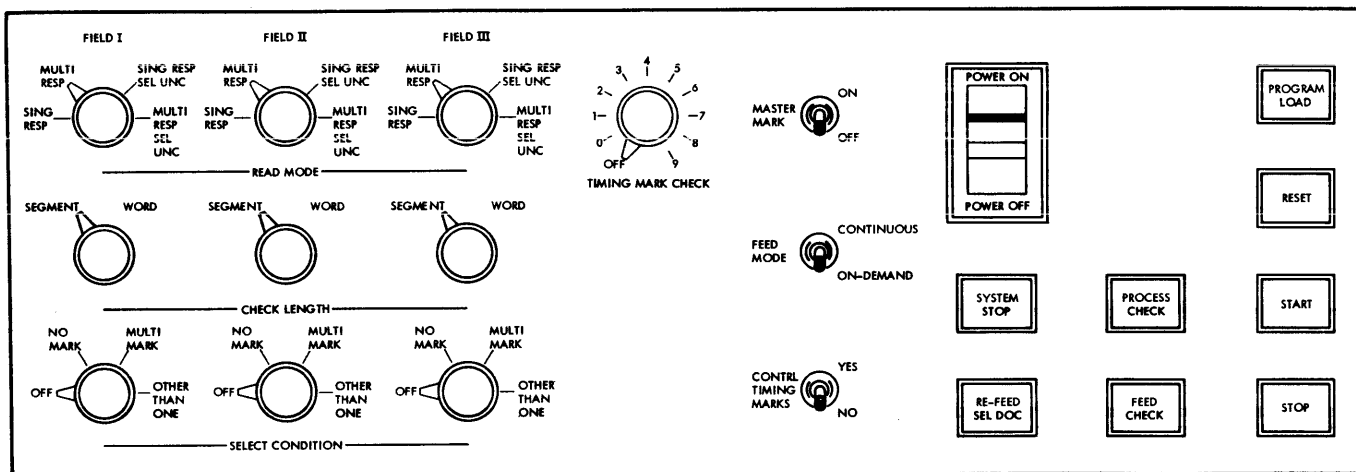

Figure 15. Operator Console (1231 upper view; 1232 lower view)

Punch Mode Switch (Special Feature): The punch mode switch (1232 only) has two settings: "Segment" and "Word". When the switch is set to SEGMENT, punching of the card in the 534 is on a segment per card column basis. When the switch is set to WORD, punching is on a word per card column basis. Master mark and identification data always punch on a word basis, regardless of the switch setting.

Check Length Switch: Three check-length switches are located on the operator's panel; one for each of three sets of switches associated with fields. These switches have two settings: "Segment" and "Word". The setting defines the length of the item as it will be checked for each field. The SEGMENT setting will check the five positions of a segment; the WORD setting will check all ten positions of a word.

Select Condition Switches: Each of the three select switches has four settings: "Off", "No Mark", "Multi-Mark", and "Other-Than-One". Each switch is associated with a check length switch and one of the three fields. The settings represent the conditions in a given field under which a document will be directed to the select stacker.

Unit Record Card Switch: When this switch is on, the 1232 operates in unit-record card mode; one card is punched for each field. When the switch is off, one card is punched for each data sheet.

Read Mode Switches: These three switches, each associated with a set of field-checking switches, determine the conditions of mark discrimination. Each read mode switch has four settings: Single Response, Multiple Response, Single Response-Select Uncertainties, and Multiple Response-Select Uncertainties. See *Mark Recognition and Discrimination* in this publication for a detailed description of each switch setting.

Control Timing Marks Switch: This switch enables the 1231 to eliminate the 75ms delay associated with the timing-mark-checking feature. The switch has two settings, "Yes" and "No". YES is used when the documents to be processed have the six, extra, control-timing marks needed for IBM 1230 operation. NO is used when no control timing marks are on the documents; the 75ms delay is eliminated.

Timing Mark Check Switch: This switch is an 11-position rotary switch with settings numbered "0 through 9" and "Off". The switch is preset by the operator to match the units-position count of timing marks on the data sheets to be processed. For example; if there were 106 timing marks on a document to be processed, the switch would be set at "6".

Lights

Start Key Light: The start key, when lit, indicates that the machine is in a ready state. The light goes off when the start key is pressed, and the light remains off until the machine is again conditioned to the ready state.

Feed Check Light: This light indicates a sheet jam, a misfeed, a double-sheet feed, a full stacker, or an empty hopper. These conditions cause the machine to stop, and the condition must be corrected before the light can be turned off by pressing the reset key.

Process Check Light: This light indicates the following conditions:

1. A parity error in storage logic.
2. The count of data-sheet timing marks is not in agreement with the setting of the timing-mark switch.
3. Failure of processing unit to take data from the B-Reg before the A-Reg loaded new data into it. See *1231 Data Flow*.
4. A logic or delay line failure when:
 - a. No control bits are loaded into the master line during the reading of a program control sheet.
 - b. No data bits are loaded during the reading of a data sheet. (Blanks normally load a C bit.)

System Stopped Light (1231 only): This light is turned on whenever the processing system is stopped while connected to the 1231.

Punch Check Light (1232 only): This light turns on when the IBM 534 Card Punch is not ready to receive information because of an empty hopper, no card in punch position, a full stacker, a card jam, a sync-check condition, or a card misfeed.

Refeed Sel Doc Light: This light comes on whenever one or more of the following conditions occurs (the last document in the select stacker must be reprocessed):

1. A multi-mark is detected during the reading of the master-mark document.
2. An uncertainty is detected during the reading of the program control sheet.
3. An uncertainty, without an accompanying dark mark, is detected during the reading of the master-mark sheet.
4. A READ instruction during continuous mode operation is received too late (1231 only).
5. A process check occurs and a new sheet has started to feed (1231 in continuous feed mode only).

Programming

Programming for the 1231 and 1232 depends upon two sources of control: controls stored within the 1231 or 1232, and controls received from the system or punch to which the 1231 or 1232 is connected. Controls stored within the reader are entered into storage from a program control sheet.

Program Control Sheet

A program control sheet is a data sheet with certain operational controls marked in the data areas. Each word from the data sheet consists of ten positions. Each word in storage consists of 16 positions; 10 for the positions on the data sheet, and six for storing operational and internal controls generated by circuitry.

Every word that is to be retained for transferral to the external connecting unit must have an operational control marked in that word on the program control sheet. When operational control information is entered into storage, the control bits go into some of the six control positions associated with each word.

During the program load cycle, the mark positions used as control positions are:

1. A mark in position eight. This designates that a word is to be stored. This word will be available later for readout to the external system or punch.
2. A mark in position zero and a mark in position eight. This will store data from segment "one" only. This ability is standard on the 1231 and available on the 1232 when the Segmented Word special feature is installed.
3. A mark in position five and a mark in position eight. This will store data from segment "two" only. This is a standard feature of the 1231 and available as a special feature (Segmented Word feature) on the 1232.
4. A mark in position three and a mark in position eight. This will store data designated as identification data, which can involve a page number, customer number, salesman number, or other data used to identify the sheet being processed. This function is available as a special feature (Multiple Spread-Card or Unit Record Card features) on the 1232. In the case of multiple cards for a single data sheet, this mark allows the identification data to be punched into every card associated with a specific sheet.

5. A mark in position six. This indicates the start of field checking according to the settings of Field I switches.
6. A mark in position seven. This indicates the start of field checking according to the settings of Field II switches.
7. marks in positions six and seven. This indicates the start of field checking according to the settings of Field III switches.
8. A mark in position one. This control is provided only with the Unit Record Card special feature. The control is used to designate the end of a group of like information, and to advance the group count by one.
9. A mark in position four and a mark in position eight designates the word as a sync-check word. This control is used only on the 1232 and must be coordinated with a sync-check card column as programmed on the 534 program card.

Figure 16 is an example of a customer order form and the spread card that can be punched from it. From this application, only one segment of the odd-words is used. The program control sheet (Figure 17) uses marks in the 8 position to store the even-words, and marks in the 5 and 8 positions (Segmented Word feature) to store the information from the odd words. Customer number and salesman number are shown being stored as identification data (marks in positions 3 and 8). This feature is available with either the Multiple Spread-Card or Unit Record Card special features.

NOTE: If the item descriptions shown in Figure 16 are printed in reflective ink, a special feature is not required in order to read the odd words. In this case, only a mark in position 8 of the program control sheet is needed.

To accommodate a customer order number, the Master Mark special feature is used (Figure 18). The 534 program card, which is used to control punching, indicates the punching of order number (master-mark data), customer number and salesman number (identification data) by the 2 punches in columns 2 through 14. The item quantities are called for by the 9 punches in columns 15 through 80. The zero in column 1 instructs the 534 to duplicate information from card to card.

Note that some items in Figure 16 are not marked with a quantity. On the program control sheet, however, all items are programmed to read and store. If the items are programmed to read but are not marked, the spread card will be spaced over the card columns representing those items. In this way, a certain item is represented by two certain card columns.

DATE 12/21/64

XYZ COMPANY

CUSTOMER NUMBER										SALESMAN NUMBER									
0	1	2	3	4	5	6	7	8	9	0	1	2	3	4	5	6	7	8	9
0	1	2	3	4	5	6	7	8	9	0	1	2	3	4	5	6	7	8	9
0	1	2	3	4	5	6	7	8	9	0	1	2	3	4	5	6	7	8	9
0	1	2	3	4	5	6	7	8	9	0	1	2	3	4	5	6	7	8	9
0	1	2	3	4	5	6	7	8	9	0	1	2	3	4	5	6	7	8	9

ITEM	QUANTITY														
	1	2	3	4	5	6	7	8	9	10	20	40	60	80	100
Band Saw Model A															
Band Saw Model B															
Band Saw Model C															
Circ. Saw Model A															
Circ. Saw Model B															
Circ. Saw Model C															
Port. Drill Model A															
Port. Drill Model B															
Drill (Floor) Model A															
Drill (Floor) Model B															
Sabre Saw Model A															
Sabre Saw Model B															
Sabre Saw Model C															
Radial Arm Saw Mod. A															
Radial Arm Saw Mod. B															
Radial Arm Saw Mod. C															
Elec. Grinder Model A															
Elec. Grinder Model B															
Elec. Grinder Model C															
Disc Sander															
Belt Sander Model A															
Belt Sander Model B															
Power Hacksaw Mod. A															
Power Hacksaw Mod. B															
Power Hacksaw Mod. C															
Elec. Hedgetrimmer A															
Elec. Hedgetrimmer															

- Lathe Model A
- Lathe Model B
- Lathe Model C
- Jointer Planer
- Molder Planer Mode
- Molder Planer Mode

CARD CODE	ORDER NO.	CUST. NO.	SLM	ITEM																																		
				1	2	3	4	5	6	7	8	9	10	11	12	13	14	15	16	17	18	19	20	21	22	23	24	25	26	27	28	29	30	31	32	33		
0	0	0	0	0	0	0	0	0	0	0	0	0	0	0	0	0	0	0	0	0	0	0	0	0	0	0	0	0	0	0	0	0	0	0	0	0	0	0
1	1	1	1	1	1	1	1	1	1	1	1	1	1	1	1	1	1	1	1	1	1	1	1	1	1	1	1	1	1	1	1	1	1	1	1	1	1	1
2	2	2	2	2	2	2	2	2	2	2	2	2	2	2	2	2	2	2	2	2	2	2	2	2	2	2	2	2	2	2	2	2	2	2	2	2	2	2
3	3	3	3	3	3	3	3	3	3	3	3	3	3	3	3	3	3	3	3	3	3	3	3	3	3	3	3	3	3	3	3	3	3	3	3	3	3	3
4	4	4	4	4	4	4	4	4	4	4	4	4	4	4	4	4	4	4	4	4	4	4	4	4	4	4	4	4	4	4	4	4	4	4	4	4	4	4
5	5	5	5	5	5	5	5	5	5	5	5	5	5	5	5	5	5	5	5	5	5	5	5	5	5	5	5	5	5	5	5	5	5	5	5	5	5	5
6	6	6	6	6	6	6	6	6	6	6	6	6	6	6	6	6	6	6	6	6	6	6	6	6	6	6	6	6	6	6	6	6	6	6	6	6	6	6
7	7	7	7	7	7	7	7	7	7	7	7	7	7	7	7	7	7	7	7	7	7	7	7	7	7	7	7	7	7	7	7	7	7	7	7	7	7	7
8	8	8	8	8	8	8	8	8	8	8	8	8	8	8	8	8	8	8	8	8	8	8	8	8	8	8	8	8	8	8	8	8	8	8	8	8	8	8
9	9	9	9	9	9	9	9	9	9	9	9	9	9	9	9	9	9	9	9	9	9	9	9	9	9	9	9	9	9	9	9	9	9	9	9	9	9	9

Figure 16. Preprinted Order Form and Spread Card

Identification Data

DATE

CUSTOMER NUMBER

SALESMAN NUMBER

Storage Load

Stone Saw Model B Only

XYZ COMPANY

ITEM

QUANTITY

Band Saw Model A

Band Saw Model B

Band Saw Model C

Circ. Saw Model A

Circ. Saw Model B

Circ. Saw Model C

Port. Drill Model A

Port. Drill Model B

Drill (Floor) Model A

Drill (Floor) Model B

Sabre Saw Model A

Sabre Saw Model B

Sabre Saw Model C

Radial Arm Saw Mod. A

Radial Arm Saw Mod. B

Radial Arm Saw Mod. C

Elec. Grinder Model A

Elec. Grinder Model B

Elec. Grinder Model C

Disc Sander

Belt Sander Model A

Belt Sander Model B

Power Hacksaw Mod. A

Power Hacksaw Mod. B

Power Hacksaw Mod. C

Elec. Hedge-trimmer A

Elec. Hedge-trimmer B

Lathe Model A

Lathe Model B

Lathe Model C

Jointer Planer

Molder Planer Model A

Molder Planer Model B

Figure 17. Program Control Sheet for Figure 16

If the 1232 is equipped with either the Multiple Spread-Card or Unit Record Card special feature, the programming for salesman number (Figure 17) could have been handled differently. By treating the customer number as identification data, and the salesman number as detail data, the two would not be punched interspersed as shown in Figure 16. In this case, the customer number field could be punched as identification data, and punched first. Salesman number would be treated as detail data and punched as the first detail data in the spread-card. Columns 12, 13, and 14 of the spread-card would identify the salesman.

On-Line Systems Programming

The IBM 1231 Optical Mark Page Reader contains all the circuitry required to read and store data from each document, and to perform field checking. All marks

read from the documents are stored as bits in the 1231 delay lines until transferred to the processing system by the execution of a READ instruction. Field-checking functions are preselected by the field check switches on the 1231 console.

The 1231 can be operated in either of two feed modes: continuous or on-demand. A two-position feed mode switch, labelled CONTINUOUS and ON-DEMAND must be set by the operator to conform to the selected method of processing unit programming.

If the switch is set to CONTINUOUS, documents will feed at a rate of 2000 per hour. In this feed mode, a READ instruction must be given by the computer program within 150 ms after buffer full in the 1231. This will occur once during every 1585 ms. Document feeding in the 1231 is automatic in this mode.

On-demand feeding mode does not require a READ

MASTER MARK DATA SHEET

BE SURE TO MAKE YOUR MARKS
HEAVY AND BLACK.

ERASE COMPLETELY ANY MARKS
YOU WISH TO CHANGE

MASTER MARK FIELD

1.	0	1	2	3	4	5	6	7	8	9
2.	0	1	2	3	4	5	6	7	8	9
3.	0	1	2	3	4	5	6	7	8	9
4.	0	1	2	3	4	5	6	7	8	9
5.	0	1	2	3	4	5	6	7	8	9

NOTE:

The number of master mark words marked must be equal to the number of columns punched (for 1232 use).
Number of timing marks should be twice this number.

ORDER INPUT CARD	CC	ORDER NO.	CUST. NO.	SLW.	ITEM																																																																											
					1	2	3	4	5	6	7	8	9	10	11	12	13	14	15	16	17	18	19	20	21	22	23	24	25	26	27	28	29	30	31	32	33																																											
	0	0	0	0	0	0	0	0	0	0	0	0	0	0	0	0	0	0	0	0	0	0	0	0	0	0	0	0	0	0	0	0	0	0	0	0	0																																											
	1	2	3	4	5	6	7	8	9	10	11	12	13	14	15	16	17	18	19	20	21	22	23	24	25	26	27	28	29	30	31	32	33	34	35	36	37	38	39	40																																								
	1	1	1	1	1	1	1	1	1	1	1	1	1	1	1	1	1	1	1	1	1	1	1	1	1	1	1	1	1	1	1	1	1	1	1	1	1	1	1	1																																								
	2	2	2	2	2	2	2	2	2	2	2	2	2	2	2	2	2	2	2	2	2	2	2	2	2	2	2	2	2	2	2	2	2	2	2	2	2	2	2	2	2																																							
	3	3	3	3	3	3	3	3	3	3	3	3	3	3	3	3	3	3	3	3	3	3	3	3	3	3	3	3	3	3	3	3	3	3	3	3	3	3	3	3	3	3																																						
	4	4	4	4	4	4	4	4	4	4	4	4	4	4	4	4	4	4	4	4	4	4	4	4	4	4	4	4	4	4	4	4	4	4	4	4	4	4	4	4	4	4	4																																					
	5	5	5	5	5	5	5	5	5	5	5	5	5	5	5	5	5	5	5	5	5	5	5	5	5	5	5	5	5	5	5	5	5	5	5	5	5	5	5	5	5	5	5																																					
	6	6	6	6	6	6	6	6	6	6	6	6	6	6	6	6	6	6	6	6	6	6	6	6	6	6	6	6	6	6	6	6	6	6	6	6	6	6	6	6	6	6	6	6																																				
	7	7	7	7	7	7	7	7	7	7	7	7	7	7	7	7	7	7	7	7	7	7	7	7	7	7	7	7	7	7	7	7	7	7	7	7	7	7	7	7	7	7	7	7	7																																			
	8	8	8	8	8	8	8	8	8	8	8	8	8	8	8	8	8	8	8	8	8	8	8	8	8	8	8	8	8	8	8	8	8	8	8	8	8	8	8	8	8	8	8	8	8																																			
	9	9	9	9	9	9	9	9	9	9	9	9	9	9	9	9	9	9	9	9	9	9	9	9	9	9	9	9	9	9	9	9	9	9	9	9	9	9	9	9	9	9	9	9	9	9																																		
	1	2	3	4	5	6	7	8	9	10	11	12	13	14	15	16	17	18	19	20	21	22	23	24	25	26	27	28	29	30	31	32	33	34	35	36	37	38	39	40	41	42	43	44	45	46	47	48	49	50	51	52	53	54	55	56	57	58	59	60	61	62	63	64	65	66	67	68	69	70	71	72	73	74	75	76	77	78	79	80

Figure 18. Master Mark Sheet and Program Card for Figure 16

instruction at any given interval. In this mode, document feeding and the rate of feeding is effectively under control of the computer-programmed READ instruction. Maximum throughput in this mode is 1600 documents per hour.

On-Line Program Instructions

Eight program instructions are provided for operating the 1231 on-line with the IBM 1401, 1440, or 1460 Data Processing Systems. The instructions; six branch (BXXXd), one read (M%*S3*XXXR), and one stacker select (KA) are all the controls and logic functions necessary when the 1231 is used as an input to these systems.

Publications explaining the specific program instructions, mnemonic codes, and detailed descriptions of continuous and on-demand program routines are listed in the *Systems Reference Library Bibliography* for the system involved.

B(XXX)1, Auto Select: This instruction tests an indicator which is set when a document is automatically selected by the 1231. The indicator will be reset when it is tested by the program. When this indicator is on, the 1231 does not transfer data to the computer for the selected document.

B(XXX)2, Buffer Full: This instruction indicates that a document has been read by the 1231, and the data has been stored in the 1231 storage. The indicator will be reset following the execution of the read instruction.

B(XXX)3, Ready to Read: This branch instruction tests an indicator that is turned on when all normal operating conditions have been satisfied and the start key has been pressed. The indicator will remain on until an interruption in the 1231 occurs.

B(XXX)4, Hopper Empty: This branch instruction distinguishes an empty hopper condition from other 1231 stop conditions. This instruction is normally used with the end-of-job routine. The branch is turned off by loading the hopper.

B(XXX)5, Read Error: This branch instruction indicates that the data in the 1231 buffer storage has not been completely transferred to the processing unit. The 1231 stops, and it is necessary to reprocess the top document in the normal pocket. This branch will be turned off when 1231 operation is resumed.

B(XXX)6, Timing Mark Check: This branch instruction indicates that the count of timing marks on the data sheet does not agree with the setting of the timing-mark check switch. Extra or missing timing marks will be detected. When the control timing marks switch is set to YES, a timing mark check indication is sent to the computer 75ms after the rise of buffer full. When the control timing marks switch is set to NO, the timing mark check indication is sent to the computer immediately following the rise of buffer full. This branch is turned off by pressing the reset key when normal operation is resumed.

M%*S3*(XXX)R, Read: This instruction causes a read-out of the data in the 1231 to the computer storage area designated by the B address. Data is transferred

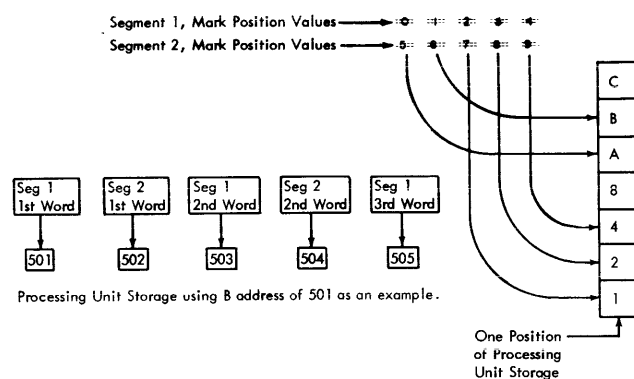

serially, high-order first. The B address is the high-order address of the computer read-in area. If the Master Mark special feature is used, the master-mark information will always precede detail data transferred to the computer.

In the On-Demand mode, sheet feed is automatic when a buffer empty condition is indicated.

KA, Stacker Select: This instruction provides for selection of certain documents at the programmer's option. The selection must be made within 50 ms after buffer full. No selection instruction is necessary to select the normal pocket.

NOTE: Documents may also be directed to the select pocket by the 1231, independent of the computer program. See field-checking switches under *Keys and Lights*.

For the specific program instructions and mnemonic codes used with the 1231, refer to the *Systems Reference Library Bibliography* for the system involved.

When properly implemented, the Optical Mark Page Readers provide economical and reliable conversion of source data into a machine-usable form. However; to achieve the best level of performance, reasonable controls should be used in the following areas:

1. Documents should be stored under controlled conditions of temperature and humidity.
2. Documents should be handled carefully to minimize mutilation.
3. When documents are being marked, proper procedures should be followed. Marks should be made with a black, lead pencil, and should completely fill the mark position. (A Number 2 pencil is recommended.) Erasures should be made carefully and completely.
4. Prior to processing documents, the machine should be properly set up.
5. Test documents should be run and checked for correct results. Selected documents should be analyzed to determine the reason for selection.

IBM 1232 Setup

When the 1232 is to operate with an IBM 534 Card Punch, the following setup sequence should be followed:

1. Set up the 534 Card Punch. See *534 Setup*.
2. Turn the main line switch to **POWER ON**.
3. Set the punch mode switch to either **WORD** or **SEGMENT**.
4. Set the timing mark check switch to the units-position count of the timing marks on the detail data sheets. This setting should agree with the count of the marks on the program control sheet. If Master Mark is being used, the count need not be set to run the master mark sheet.
5. Set the master-mark switch and/or the unit record card switch to the appropriate position.
6. Set the field-checking switches to their proper settings. The check-length switch should be set to either **WORD** or **SEGMENT**; the select-condition switch should be set to **OFF**, **NO MARK**, **MULTI-MARK**, or **OTHER-THAN-ONE**; the read mode switch should be set to **SING RESP**, **MULT RESP**, **SING RESP SEL UNC**, or **MULT RESP SEL UNC**.
7. Joggle the data sheets and place them in the hopper face up, top edge to the left. The program control sheet must be the top document. The documents should be well-joggled to keep the edges as even as possible. If master-mark data sheets are used, place them on top of the detail data sheets to which they apply.

8. Press **RESET**. This raises the hopper to feeding position.
9. Press **PROGRAM LOAD** to clear previous control bits.
10. Check the adjustment of the front hopper side plate. The documents should be held against the rear side plate without binding. Check for a bind by gently depressing the hopper platform about 1/2 inch. It should return quickly to normal operating height.
11. Press **START**. This will feed the program control sheet. The machine will stop after the program control sheet has been read.
12. Press **START**. This will start the feeding of the detail sheets. Feeding will now be controlled by a sheet-feed instruction from the 534 program card. When either the Multiple Spread-Card or Unit Record Card special feature is installed, feeding is controlled by sensing a 1232 buffer-empty condition.
13. Check the punched output from the first card against the data read.

IBM 534 Setup

Setting up the IBM 534 Card Punch for operation with the 1232 requires the following procedures:

1. Turn the mainline switch on.
2. Mount the proper program card onto the program drum.
3. Position the program drum on the shaft and lower the starwheels to reading position.
4. Press the release key to position all starwheels.
5. Load blank cards into the hopper.
6. Press the feed key once.
7. Turn the auto feed and auto skip/auto dup switches on.
8. Turn the auto punch/key punch switch to **AUTO PUNCH**.
9. If information is to be duplicated, slip the master duplication card into the feed slots at the read station and press the feed key. If no information is to be duplicated, press the feed key and then the release key so that a card is registered at both the read station and the punch station.

IBM 1231 Setup

A fully-loaded 1231 is set up according to the following procedure:

1. Turn the main line switch to **POWER ON**.
2. Set the feed mode switch to either **CONTINUOUS** or **ON-DEMAND**.
3. Set the timing mark check switch to the units

position count of the timing marks on the detail data sheet. This number should agree with the count of the marks on the program-control sheet. When master-mark sheets are processed, they are not checked for a timing mark count.

4. Set the control timing marks switch to YES or NO, depending on whether or not IBM 1230 processable documents are being read.
5. Set the master-mark switch to either ON or OFF, depending upon the application.
6. Set the field-checking switches to their proper settings. The check-length switches should be set to either WORD or SEGMENT; the select condition switches should be set to OFF, NO-MARK, or OTHER-THAN-ONE; the read mode switch should be set to SING RESP, MULT RESP, SING RESP SEL UNC or MULT RESP SEL UNC.
7. Joggle the data sheets and place them in the hopper face up, top edge to the left; and place the program-control sheet on top. If the Master-Mark feature is used, place the master-mark sheet for the first group on top of the first group. The documents must be well-joggled, prior to insertion in the hopper, to keep the edges even and to ensure straight feeding.
8. Press PROGRAM LOAD to clear storage.
9. Press RESET to raise the hopper to feeding position. The front hopper side plate is operator-adjustable. This plate should keep the documents against the rear hopper side plate without binding. To check for binds, depress the hopper platform about 1/2 inch. The platform should return to normal operating height without hesitation.
10. Press START. This will feed the program-control sheet and the machine will stop.

11. Press START. Sheets will feed immediately when the feed mode switch is set to CONTINUOUS and the system is not in a "halt" condition. If the system is in a "halt" condition, the start key on the system must be pressed before feeding will start.

When the feed-mode switch is set at ON-DEMAND, pressing the start key causes one data sheet to feed. Further feeding of documents is under control of the computer-programmed READ instruction; as soon as the buffer has been read out, the next data sheet is fed automatically.

Restart Procedures

Restart procedures for the 1231 and 1232 are similar. Generally, if a condition occurs which causes the 1231/1232 hopper to lower, caution must be exercised in restoring operation. *When the machine is in a stopped condition, pressing of RESET in either the 1231 or 1232 will destroy data in the Optical Mark Page Reader's storage.* This will leave part of a card unpunched, or prevent transfer of a complete data sheet to the computer.

Pressing of the stop key on the 1231/1232 causes the machine to complete the processing of the data sheet being read (or just read), then causes the hopper platform to lower. In order to return the hopper platform to proper feeding level, the reset key must be pressed. *Any time that RESET is pressed to raise the hopper platform, care must be exercised to ensure that the last document read has been completely processed. This is accomplished by placing the receiving unit (either the processing unit or the 534 punch) in operating condition, and allowing the unit to complete the processing before pressing the reset key on the Optical Mark Page Reader.*

Operator procedures for various stop conditions are contained in the following chart:

INDICATION	CAUSE	RESTART PROCEDURE
Feed Check Light	Document Misfeed	<ol style="list-style-type: none"> 1. Press STOP. 2. Clear document (if necessary). 3. Press 534 release key (1232 only) and destroy card just released. 4. Place document(s) to be reprocessed on top of documents in hopper. If jammed document had passed read head it need not be reprocessed. 5. Press RESET. 6. Press START.
Feed Check Light	Empty 1231/1232 hopper	<ol style="list-style-type: none"> 1. Refill hopper. 2. Press RESET. 3. Press START.
Feed Check Light	Full Stacker 1231/1232	<ol style="list-style-type: none"> 1. Empty stacker. 2. Press RESET. 3. Press START.

INDICATION	CAUSE	RESTART PROCEDURE
Feed Check Light	More than one data sheet fed	<ol style="list-style-type: none"> 1. Press release key on 534 and destroy card just released if it has started punching. 2. Press RESET and STOP. Hold both keys depressed until double-feed documents have been completely run out. 3. Place documents to be reprocessed on top of documents in 1231/1232 hopper. 4. Press RESET to raise hopper platform. 5. Press START.
Punch Check Light (1232)	Empty Hopper (534)	<ol style="list-style-type: none"> 1. Refill 534 hopper. 2. Press the 534 feed key two times. Operation resumes automatically. NOTE: If the 1232 is to be filled while the 534 is stopped: <ol style="list-style-type: none"> 1. Refill 534 hopper and press 534 feed key two times. 2. After the 534 completes any punching to be done on the last data sheet, press the 1232 stop key. 3. Fill the 1232 hopper, putting the added data sheets under the ones still in the hopper if any sequence must be kept. 4. Press the 1232 reset key. 5. Press the 1232 start key.
System Stopped Light (1231)	Processing Unit is in a "halt" condition	<p>If the processing unit halt condition is not caused by the 1231, no 1231 action is required. If operating in "Continuous" feed mode and if REFEEED SEL DOC is also lit, the last document read must be reprocessed. In this case:</p> <ol style="list-style-type: none"> 1. Press STOP. 2. Remove the top document from the select stacker and place it on top of the documents in the hopper. 3. Press RESET. 4. Press START.
Process Check Light (1232)	Parity error detected	<ol style="list-style-type: none"> 1. Release and destroy card being punched in 534 when stop occurred. 2. Reload program control sheet. (If pressing RESET does not clear Process Check Light). 3. Any document not past the read head should be placed on top of documents in the hopper. 4. Press RESET. 5. Press START.
Process Check Light (1231)	Parity error detected. The error may be caused by a slow-starting clock in the computer, a timing-mark check, or a failure of data to load into 1231 storage.	<ol style="list-style-type: none"> 1. Place last data sheet in normal stacker back on top of documents in hopper. 2. Press RESET. If PROCESS CHECK light does not turn out, the program control sheet must be reloaded and the procedure under <i>1231 SETUP</i> must be followed. 3. Press START.

INDICATION	CAUSE	RESTART PROCEDURE
Process Check Light (1231) with Re-feed Sel Doc Light	Parity error detected too late to stop the signal to feed the next doc.	Similar to procedure under Process Check Light 1231 except that two documents are reprocessed; one from the normal stacker and one from the select stacker.
Punch Check Light (1232)	Card misfeed (534) or a sync-check condition detected.	<ol style="list-style-type: none"> 1. Simultaneously press STOP and RESET; hold these keys depressed until all data sheets have run out of the 1232. 2. Remove any cards from the 534 involved in the misfeed. Destroy these cards. 3. Determine which card was the last correctly punched card. If Multiple Spread-card or Unit Record Card feature is being used, find first card associated with data sheet being read at time of jam. Destroy it and all succeeding cards. 4. Place the 534 back to the previous operating status by feeding cards to properly register a card at the punch station. If there is duplicated data, remove the last good card from the stacker and hand register it at the 534 read station. 5. Locate, in the 1232 normal stacker, the data sheet read when the jam occurred. 6. Place document(s) to be reprocessed on top of documents in the 1232 hopper. 7. Press RESET. 8. Press START.
Punch Check Light (1232)	Full Stacker (534)	1. Empty the 534 stacker. Restart is automatic.

Master Mark Feature

Whenever Optical Mark Page Readers are equipped with the Master Mark special feature, they can recognize a master data sheet and retain up to 10 words of information from the sheet. The master data sheet is identified by a special, preprinted mark similar to the timing marks, and located between the timing marks and the right edge of the data sheet (Figure 18). Master data information represents data that is to be associated with all subsequent data sheets until a new master sheet is read. Thus, data that is common to a series of data sheets needs to be entered only once. The total storage capacity of the 1231 is increased by 10 words when this feature is installed.

Whenever the Master Mark feature is installed, the first ten words of storage are reserved for use by this feature. If the master mark switch is on, master-mark data will read in and change whenever a new master mark is recognized. At the time the master sheet is being read, data is automatically checked for multi-marks. If multi-marks are detected, the document is selected and the Refeed Sel Doc light turns on. If the master mark switch is off, the first data read from the data sheet goes into storage position 11 in the 1232, and into storage word position 12 in the 1231.

Whenever the 1231 is equipped with this feature, 20 positions of computer storage must be reserved for the ten words of master-mark storage. Whenever the 1232 is equipped with this feature, it is possible, through master-mark switch control, to punch the master data into all cards being punched until a new master sheet has been read. New master information automatically clears the storage unit of any previous master data.

When fewer than 10 columns of master-mark data are to be punched, the number of timing marks printed on the master-mark data sheet must be reduced accordingly. For example; if six columns of master-mark data were to be punched, no more or no less than 12 timing marks should be printed on the master-mark data sheet.

Whenever 20 timing marks are printed on the master-mark data sheet, 10 words of information will be transferred to the punch before any identification data will transfer.

NOTE: Master-mark data and identification data are called for by the same program card code in the 534. It is, therefore, imperative that the correct number of timing marks be printed for the application.

Segmented Word Feature

This feature, available on the 1232 only, provides two separate functions: (1) the ability to read and punch one segment at a time, and (2) the ability to punch one word into two card columns.

Under control of the punch mode switch, each word of detail data on the data sheet can be treated as two units of information. A two-position switch marked SEGMENT and WORD controls the mode of operation. When the switch is set to SEGMENT, marks in positions 0 through 4 are directed into one card column, and marks in positions 5 through 9 punch in the next card column. When the switch is set to WORD, each word in storage is punched into one card column. In either segment or word mode of operation, a maximum of three punches can be punched into any one card column. For example: if the punch mode switch were set to WORD, and positions 3, 7, and 9 were marked, the associated card column would be punched with 3, 7, and 9 punches (Figure 19). If more than three marks were read in one segment (while in segment mode) or in one word (while in word mode), a 12 punch would be substituted for the normal punches.

NOTE: When the punch mode switch is set to SEGMENT, master mark and/or identification data is punched on a word-per-card-column basis. Detail data punches on a segment-per-card-column basis. Master-mark data is available when the Master Mark special feature is installed; identification data is available when either the Multiple Spread-Card or Unit Record Card special features are installed.

Another function of the Segmented Word feature allows the reading of only one segment of any word or words on the data sheet (see *Program Control Sheet*, items 2 and 3). Data sheets can be processed, which contain non-reflective inks in one segment (such as a listing from a high-speed printer or handwritten information), while the other segment can be used for marking data. Complete programming flexibility is available so that any segment can be read or not read according to job requirements. If only one segment of a word is programmed to read, only one column of the card is punched for that word.

Special Card Features

Two special features, Multiple Spread-Card and Unit Record Card, are available for the 1232, and enable full utilization of a data sheet as an entry form. However,

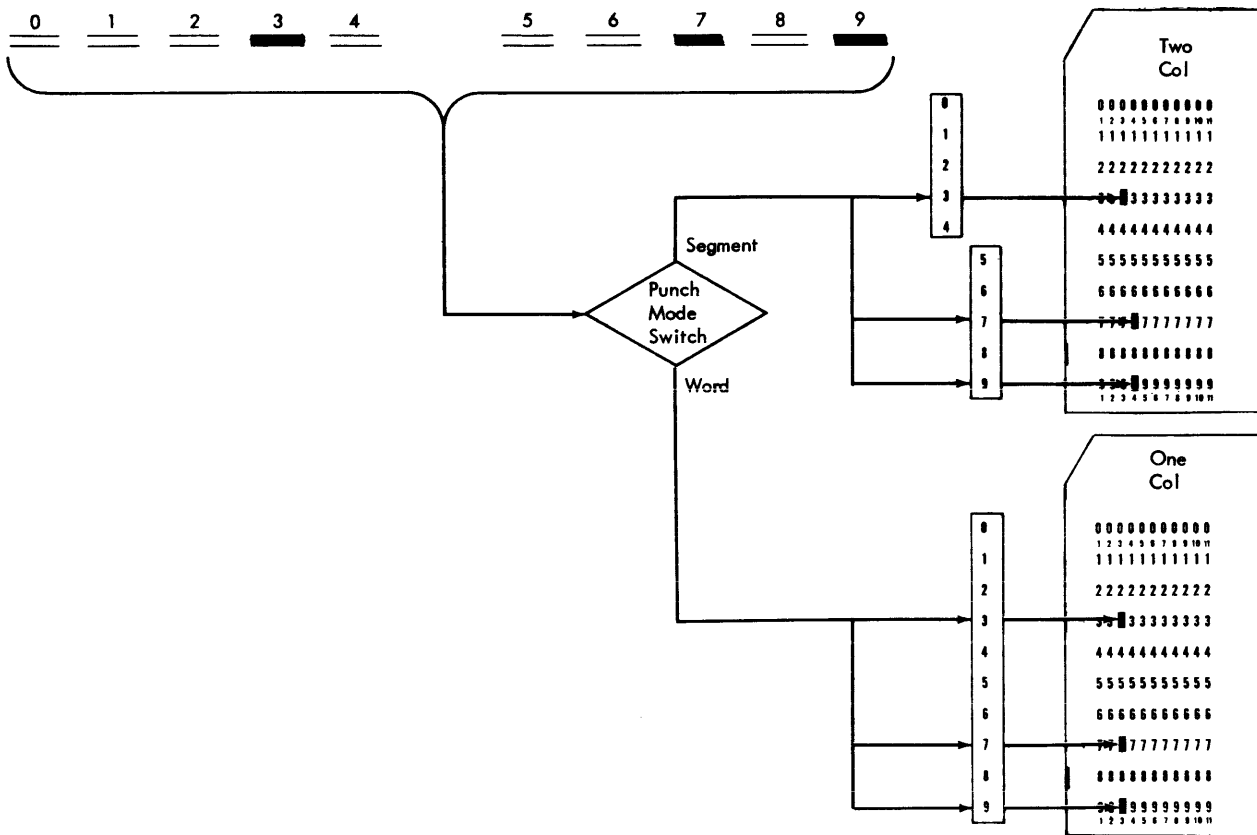

Figure 19. Segment and Word Schematic

both features cannot be installed on the same 1232.

Normally, the Multiple Spread-Card feature is used when data is intended for entry into a computer. This feature enables several items of detail data to be punched into a single card, with up to four cards punched per data sheet.

The Unit Record Card feature, which is used mainly with punched card equipment, allows a separate card to be punched for each item of detail data on the data sheet, up to a maximum of 99 cards.

Because each card produced for a data sheet must also carry some identification to its data sheet, both of these special features can separate identification data from detail data. Thus, each card produced for a given data sheet can have identification punching in it.

Multiple Spread-Card Feature

This feature is available on the 1232 only, and allows up to four cards to be punched for each data sheet read. The following four types of information can be punched into each card punched for any one data sheet:

1. Master-mark data (if the Master Mark special feature is installed).
2. Identification data (page number, customer number, etc.).

3. A portion of the detail data (detail data is divided equally among all cards punched for the data sheet).
4. Card number (a machine generated sequence number identifying a particular card of the sequence punched for each data sheet). *Card number must be programmed (in the 534 program card) to punch either preceding or following the master/identification data fields.*

The functional logic for the Multiple Spread-Card feature is shown in Figure 20. Note that the master mark and identification data are punched into each card. The number of card columns punched in the detail field of each card must be the same. The number of words or segments of detail data divided by the number of cards to be punched for each data sheet determines the number of detail field columns that must be punched in each card. When the punch mode switch is set to SEGMENT (Segmented Word Feature), each word of detail data in storage is punched into two card columns.

The master mark or identification data fields may be split or preceded by other types of data (detail, duplicated, or skips) as long as the card number field either precedes or follows the master/identification data fields. *The last information programmed to punch from the 1232 must be detail data.*

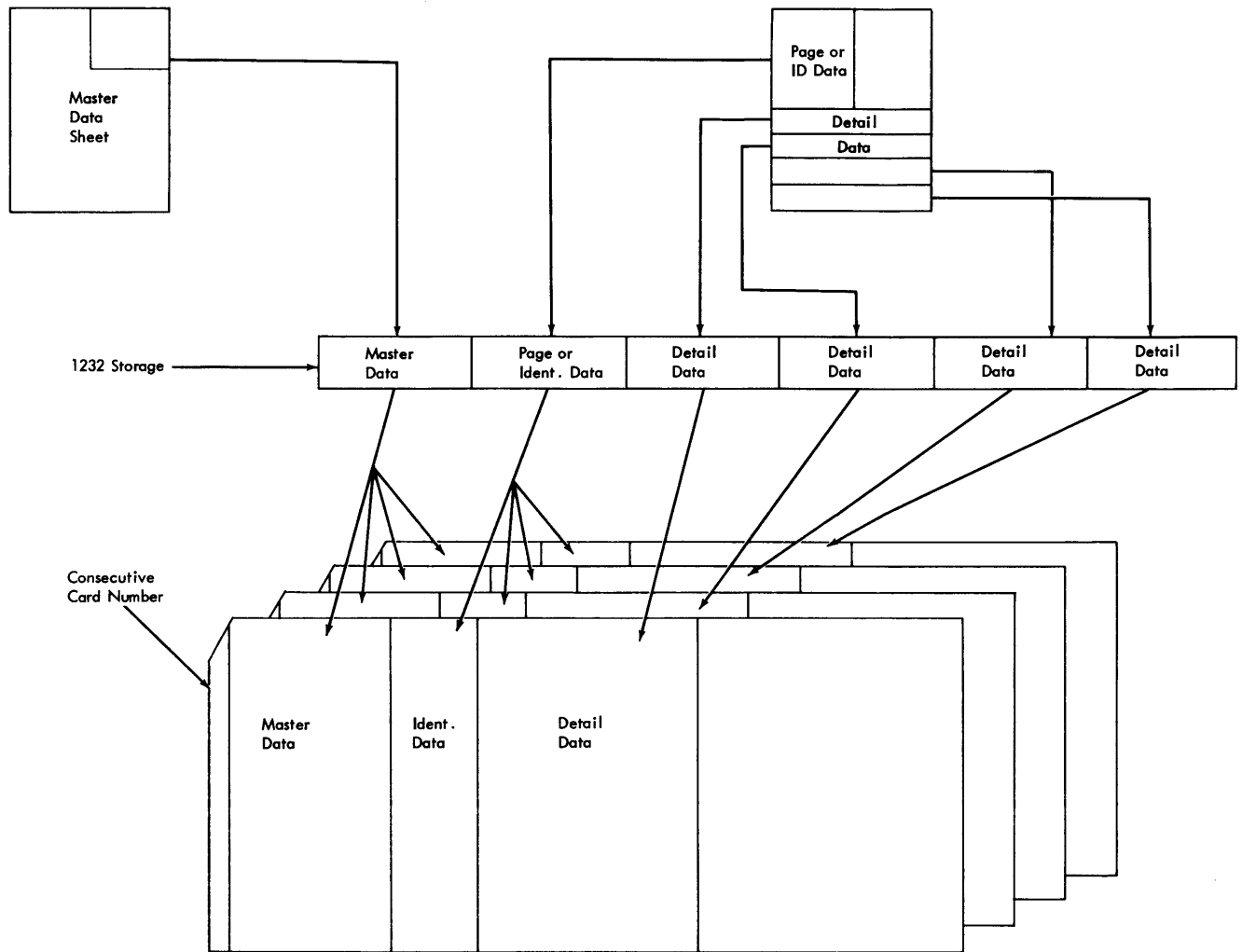

● Figure 20. Multiple Spread-Card Data Flow

If the number of stored words from the data sheet cannot be divided so that the card fields are even in column number, the width of the card fields should be increased by one column. For example; if 62 words or segments are to be punched into four cards, each of the first three cards would have 16 columns punched. This would leave 14 columns in the fourth card. In punching the fourth card, the machine would detect an empty storage condition after the fourteenth column and automatically signal the 534 to skip the card out, leaving the last two columns in this field blank. (Not more than three columns should have to be skipped if the field length is set up properly.)

When the number of cards to be punched for a given data sheet is calculated, the total effect of the number of columns of master-mark data, identification data, card-number data and detail data must be considered. Master data, identification data and card number go into each card; detail data is split into as many cards as necessary. To determine the number of cards needed for an application, let "K" represent the total number of columns (master, identification, duplicated, skipped, and card

number columns). Then, 80 minus K equals the number of columns available in each card for detail data punching. The number of detail data columns needed, divided by the quantity of 80 minus K, will equal the number of cards needed for the application. When this formula is used, any fraction of a card must be considered as a whole card.

Assume that in a typical application there are ten columns of master data, ten columns of identification data, and six columns of duplicated data. Then, K equals 10 plus 10 plus 6 plus 1 (card number), and 80 minus K equals 53. If there were 130 segments on the data sheet to be punched, then 130 divided by 53 equals the number of cards to be punched. Because this division equals 2.45, three must be used as the number of cards to be punched. Three will not divide equally into 130 (43.3) so the detail field must be set at 44 columns. Skipping of the two blank columns on the last card will be automatic (three times 44 equals 132). The number of columns punched into each card is determined by the number of 9's punched in the 534 program card. Each 9 in the program card calls for a column of detail data to be punched.

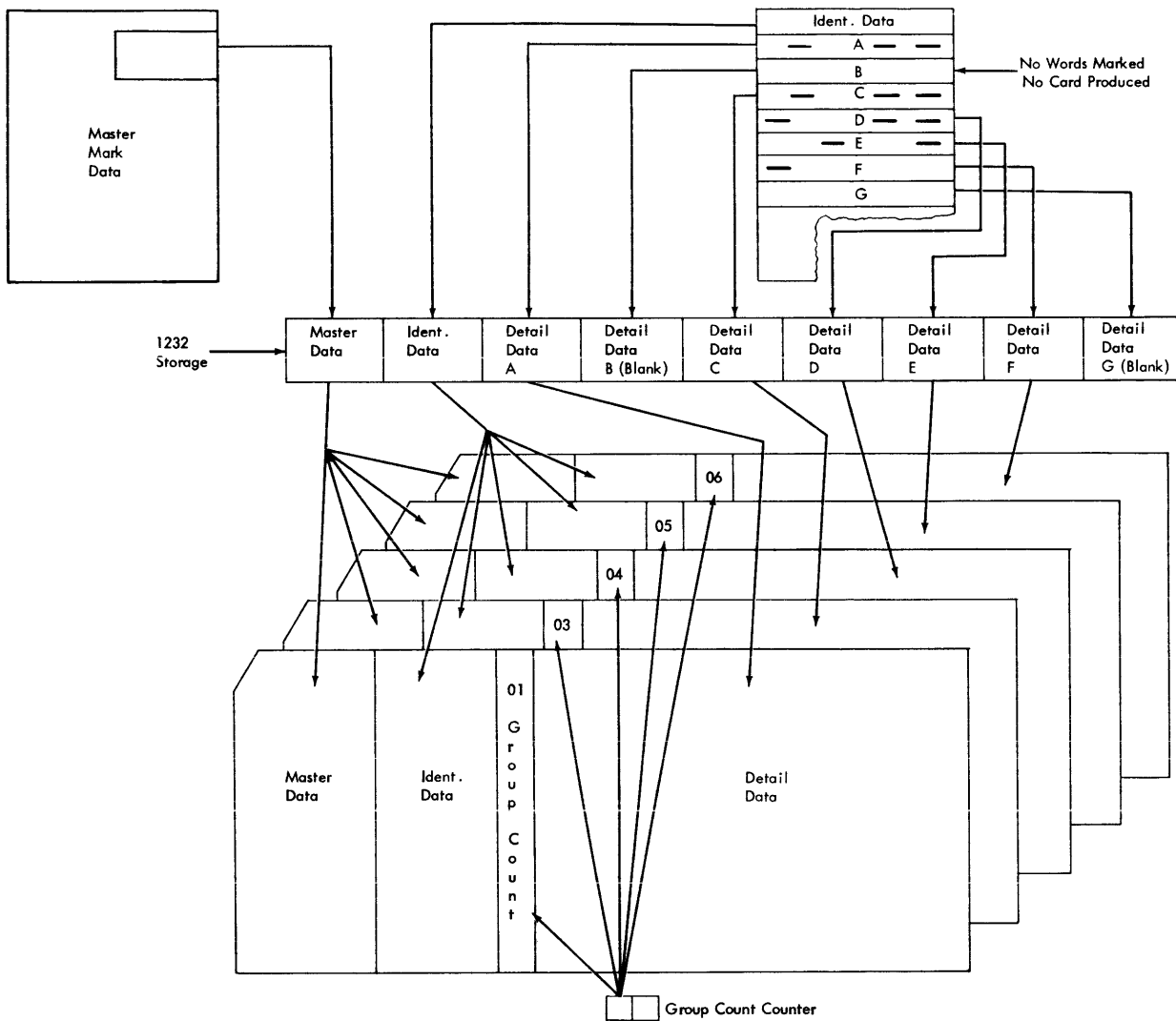

Figure 21. Unit Record Card Data Flow

Unit Record Card Feature

This feature, available only on the 1232, enables the 1232/534 to punch a separate card for each group of data on a data sheet. A group of data consists of all the words programmed to read between any two programmed end-of-group marks. Cards will be produced for all groups of data in which at least one word of detail data has been marked. No cards are punched for any group of data which has not been marked. Also, if the data sheet is selected by 1232 circuitry because of some reading or marking error, no card is produced for that data sheet. Each card produced can contain:

1. Master-mark information (if the Master Mark feature is installed and being used).
2. Identification data (page number, order number, salesman number, etc.).

3. Group number (identifies a particular item or group of information).
4. Marked detail data (quantity).

Words in a group of data can be of any number and in any format as long as an equal number of words is programmed to read. This satisfies 534 programming.

The 1232 can count the number of end-of-group marks (up to 99), and this number can be punched into a card by the 534. Group-count punching requires two card columns. The counter is restored to a count of "one" when a new data sheet is fed. Group count must be programmed to punch either before or after master-identification data fields. The master-identification data fields can be split by detail data, duplicated data, or by skips (but not by group count) as long as the last data programmed to punch from the 1232 is detail data.

The functional logic of the Unit Record Card feature is shown in Figure 21. Master-mark data and identification data, if used, is punched into every card. When the Master Mark feature is used, master-mark data changes only when a new master-mark data sheet is read. Identification data changes with each new data sheet read. Master-mark data and identification data are both called for by the same punch in the 534 program card (a 2-punch). When the Master Mark feature is being used, master-mark data always precedes identification data in the punch-out sequence.

A sample application of the Unit Record Card special feature is shown in Figures 22 and 23. The data on the left half of the data sheet in Figure 22 is coded as identification data. This data is common to all detail data

(in this case, the distributions) and is punched into the first part of the cards shown in Figure 23. The data on the right half of the data sheet is treated as detail data. In this example, all distributions were marked. If, however, one of the distribution fields was not marked, no card would have been punched for that distribution.

NOTE: On the program control sheet, the last word in each of the distribution fields would contain an end-of-group code for defining the end of the fields.

The 534 program card, used to control the punching of the cards shown in Figure 23, would be punched with 3's in columns one and two (to punch group or card number), with 2's in columns 3 through 24 (to punch the repetitive identification information), and with 9's in columns 25 through 37 (to punch the detail data).

MAINTENANCE CHARGE DISTRIBUTION

MARK COMPLETELY ALL DATA ON THIS SIDE

MARK COMPLETELY ALL DISTRIBUTIONS WHICH APPLY

CHARGE TICKET NO.									
0	1	2	3	4	5	6	7	8	9
0	1	2	3	4	5	6	7	8	9

DATE										
0	1	2	3	4	MONTH	5	6	7	8	9
0	1	2	3	4	DAY	5	6	7	8	9

ORIGINATING DEPT NO.									
0	1	2	3	4	5	6	7	8	9
0	1	2	3	4	5	6	7	8	9
0	1	2	3	4	5	6	7	8	9

APPROVED BY MAN NO.									
0	1	2	3	4	5	6	7	8	9
0	1	2	3	4	5	6	7	8	9
0	1	2	3	4	5	6	7	8	9

MAKE ALL MARKS WITH A BLACK NO. 2 LEAD PENCIL.
ERASE COMPLETELY ANY MARKS CHANGED.

APPROVAL SIGNATURE _____

FIRST DISTRIBUTION										
0	1	2	3	4	DEPT	5	6	7	8	9
0	1	2	3	4	NO.	5	6	7	8	9
0	1	2	3	4	DOLLAR	5	6	7	8	9
0	1	2	3	4	AMT.	5	6	7	8	9
0	1	2	3	4	CENTS	5	6	7	8	9

SECOND DISTRIBUTION										
0	1	2	3	4	DEPT	5	6	7	8	9
0	1	2	3	4	NO.	5	6	7	8	9
0	1	2	3	4	DOLLAR	5	6	7	8	9
0	1	2	3	4	AMT.	5	6	7	8	9
0	1	2	3	4	CENTS	5	6	7	8	9

THIRD DISTRIBUTION										
0	1	2	3	4	DEPT	5	6	7	8	9
0	1	2	3	4	NO.	5	6	7	8	9
0	1	2	3	4	DOLLAR	5	6	7	8	9
0	1	2	3	4	AMT.	5	6	7	8	9
0	1	2	3	4	CENTS	5	6	7	8	9

● Figure 22. Sample Data Sheet for Unit Record Application

D I S T N O	CHARGE TICKET NUMBER	DATE			ORIGINATING DEPARTMENT NUMBER	APPROVAL MAN NUMBER	DISTRIBUTION																																	
		MO	DA				DEPARTMENT NUMBER	AMOUNT																																
0	0000	00	00	000000	000000	000000	000000	000000																																
1	1111	11	11	111111	111111	111111	111111	111111																																
2	2222	22	22	222222	222222	222222	222222	222222																																
3	3333	33	33	333333	333333	333333	333333	333333																																
4	4444	44	44	444444	444444	444444	444444	444444																																
5	5555	55	55	555555	555555	555555	555555	555555																																
6	6666	66	66	666666	666666	666666	666666	666666																																
7	7777	77	77	777777	777777	777777	777777	777777																																
8	8888	88	88	888888	888888	888888	888888	888888																																
9	9999	99	99	999999	999999	999999	999999	999999																																

D I S T N O	CHARGE TICKET NUMBER	DATE			ORIGINATING DEPARTMENT NUMBER	APPROVAL MAN NUMBER	DISTRIBUTION																																	
		MO	DA				DEPARTMENT NUMBER	AMOUNT																																
0	0000	00	00	000000	000000	000000	000000	000000																																
1	1111	11	11	111111	111111	111111	111111	111111																																
2	2222	22	22	222222	222222	222222	222222	222222																																
3	3333	33	33	333333	333333	333333	333333	333333																																
4	4444	44	44	444444	444444	444444	444444	444444																																
5	5555	55	55	555555	555555	555555	555555	555555																																
6	6666	66	66	666666	666666	666666	666666	666666																																
7	7777	77	77	777777	777777	777777	777777	777777																																
8	8888	88	88	888888	888888	888888	888888	888888																																
9	9999	99	99	999999	999999	999999	999999	999999																																

D I S T N O	CHARGE TICKET NUMBER	DATE			ORIGINATING DEPARTMENT NUMBER	APPROVAL MAN NUMBER	DISTRIBUTION																																	
		MO	DA				DEPARTMENT NUMBER	AMOUNT																																
0	0000	00	00	000000	000000	000000	000000	000000																																
1	1111	11	11	111111	111111	111111	111111	111111																																
2	2222	22	22	222222	222222	222222	222222	222222																																
3	3333	33	33	333333	333333	333333	333333	333333																																
4	4444	44	44	444444	444444	444444	444444	444444																																
5	5555	55	55	555555	555555	555555	555555	555555																																
6	6666	66	66	666666	666666	666666	666666	666666																																
7	7777	77	77	777777	777777	777777	777777	777777																																
8	8888	88	88	888888	888888	888888	888888	888888																																
9	9999	99	99	999999	999999	999999	999999	999999																																

● Figure 23. Cards Punched From Data Sheet in Figure 22

IBM 534 Model 3 Card Punch

An IBM 534 Card Punch, cable-connected to the 1232, punches information from data sheets into 80-column cards. Punching is controlled by instructions from the 534 program card and the 1232 program control sheet. The 534 can also be used as an independent card punch.

Information is punched on a mark position digit value for punch digit basis. If more than three marks are read for punching into one card column, a 12-punch is substituted for the marked digit values.

An 11-punch, punched into column 81, indicates that the data sheet was not selected and that the information punched was valid. When using the Multiple Spread-Card special feature, at least one card associated with a data sheet will not have an 11-punch if the data sheet is selected, or if an error is detected.

All cards associated with a selected data sheet should be destroyed before reprocessing the data sheet.

Punch Controls

The following switches and keys on the keyboard of the 534 (Figure 24) are operative with the 1232:

- Feed Key
- Release Key
- Auto Feed Switch
- Auto Skip Dup Switch
- Auto Punch/Keypunch Switch

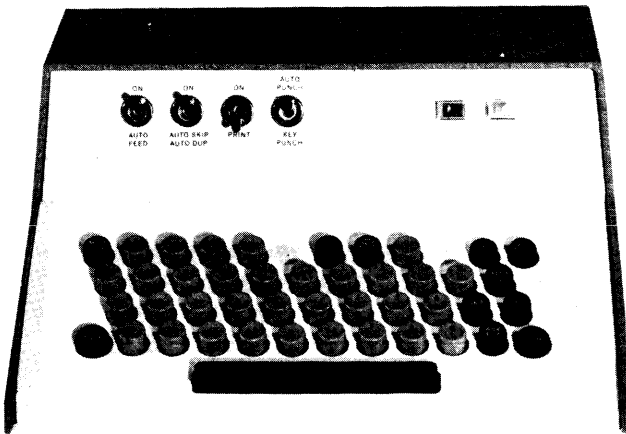

Figure 24. IBM 534 Keyboard

The switches on the 534 keyboard must be on when the punch is operating with the 1232. A main line switch is located under the reading table. This switch controls power to the 534 punch.

When the 534 is to be used as an independent card punch, the auto punch switch must be set to **KEYPUNCH**.

A Punch On light, on the 534 keyboard, turns on when the 534 main line switch is turned on.

Programming

The IBM 534 has a program drum that rotates on a column-for-column basis in synchronization with both the punch and read stations. A program card is mounted on the program drum and can be punched to control 534 functions such as skipping and duplicating. Program card functions for skipping and duplicating are identical to those of the IBM 024 Card Punch. An explanation of the 024 program card codes is available in the *IBM 024—26 Reference Manual*.

When the program card is also to be used to control a connected IBM 1232, additional controls are used. These additional controls, punched into the program card in the columns into which data is to be punched, are:

PUNCH IN PROGRAM CARD	FUNCTION
2	Punch Master or Identification Data: Must be punched into every column in which master or identification data will be punched.
3	Card Number or Field Number (two columns): Must precede or follow the entire Master-Identification fields as identified by a 2-punch in the program card.
6	Sync-Check Card Column: This card column must coincide with the sync-check word on the data sheet.
8	Sheet Feed: Causes 1232 sheet feed. When either the Multiple Spread-Card or Unit Record Card feature is being used, <i>this instruction is not needed and should not be used.</i>
9	Punch Detail Data: Must be punched in every column in which detail data is to be punched.

Unless one of the multiple-card features is used, information is punched into the card in the same sequence as read from the data sheet.

When either the Multiple Spread-Card or Unit Record Card special feature is installed, identification data can be punched separately. Identification data, as a class of data, can be programmed in the 534 to punch out entirely before any detail data is punched, regardless of the intermixing of the data on the data sheet. Detail data must be the last data punched from the 1232 data sheet.

Throughput Factors

IBM 1231 Throughput

Document format has little effect on throughput for the 1231 on-line machine. A carefully-selected 1231 document format can, however, minimize the number of computer program steps and the time required to assemble or reorganize the data in storage. Note that the data sheet reads left word, right word, left word, etc. If possible, like data should be grouped and transferred in sequence to computer storage.

IBM 1232/534 Throughput

The data sheet throughput and the number of cards produced per hour by the 1232/534 system depends upon:

1. Location and density of marks on the data sheet.
2. The number of card columns to be punched.
3. The number of cards to be punched for each data sheet. (Multiple Spread-Card or Unit Record Card features.)

Use of the following guides will help to maintain maximum data-sheet and punched-card throughput:

1. Data to be read by the 1232 should be located as near the top of the data sheet as possible. This eliminates paper-feeding time before punching can begin.
2. Data should be arranged as compactly (consecutive words) as possible. This eliminates punch-waiting time between card columns.
3. Read data should not be intermixed with data not to be read. For example; all fields not intended for reading (space for handwritten material), should be located below the fields to be read.
4. Punch on a word basis rather than on a segment basis whenever possible; fewer card columns are punched.

To assist in pre-installation planning, Figures 25 through 29 have been prepared as typical examples of 1232/534 throughput. The throughput rates in these graphs are based on the following assumptions:

1. The density of the marks on the data sheet is such that after punching has begun no interruption will occur.
2. Punching is not allowed until a data sheet has been recognized as a detail data sheet (as opposed to a master-mark data sheet).

3. Sheet Feed will be programmed in the 534 program card in the last card column to be punched (Figure 25 only).

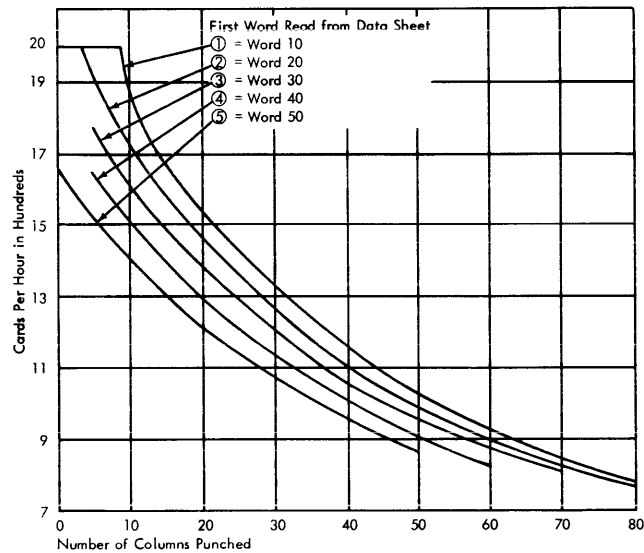

Figure 25. 1232/534 Throughput—One Card Per Data Sheet

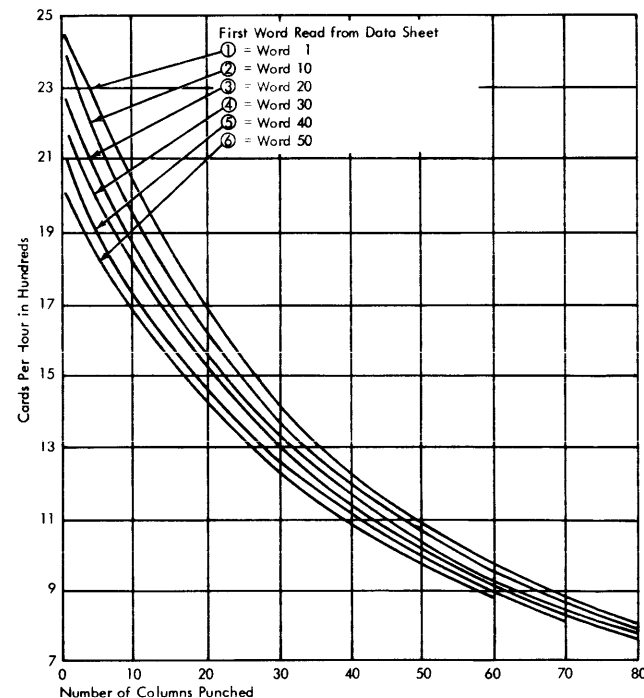

Figure 26. 1232/534 Throughput—Two Cards Per Data Sheet

4. The ratio of master-mark data sheets to detail data sheets is insignificant; the time consumed in reading master-mark data sheets is small enough that overall throughput rates will not be materially affected.

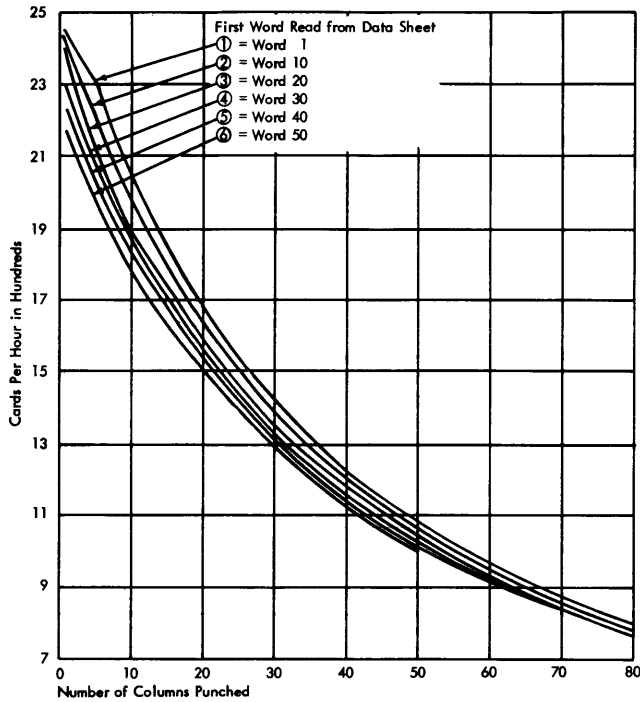

Figure 27. 1232/534 Throughput—Three Cards Per Data Sheet

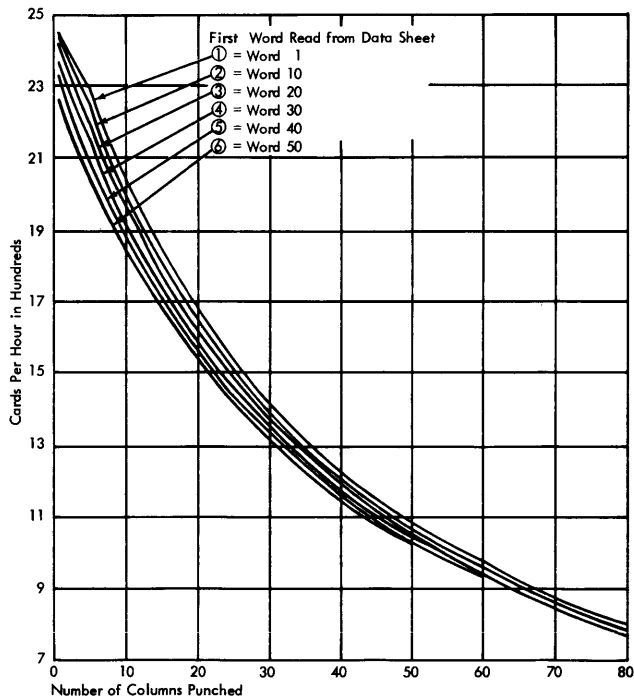

Figure 28. 1232/534 Throughput—Four Cards Per Data Sheet

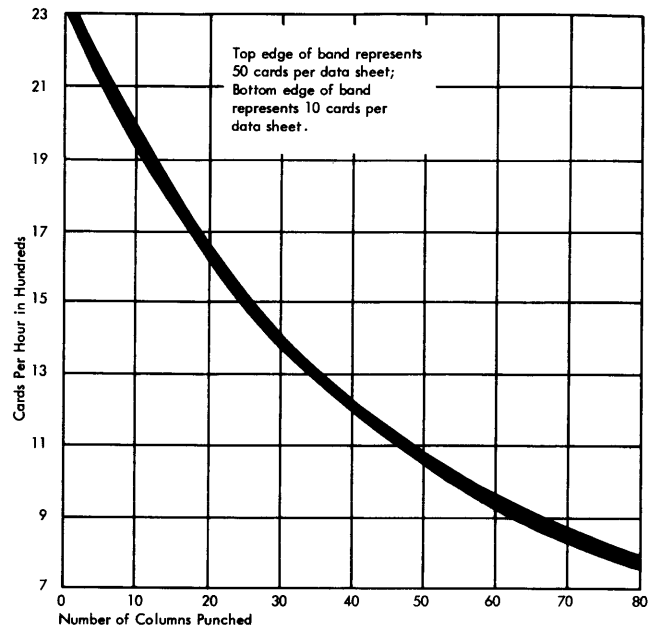

Figure 29. 1232/534 Throughput—Unit Record Card Feature

Document Design and Specifications

Certain guides must be followed in the design of data sheets for use in the IBM 1231 and 1232 Optical Mark Page Readers. These guides are divided into two main groups: those required for proper machine function, and those that facilitate efficient document design.

Specifications

The following specifications concern primarily the printing of documents; paper quality and weight, ink requirements, printing registration tolerances, etc. However; these specifications should also be considered by the data-sheet designer. His layout must not violate the document specifications.

NOTE: All reflectance readings should be measured with a Kidder Mark Tester* (MR8) or equivalent.

Paper Requirements

SIZE: 8 1/2" \pm .015" by 11" \pm .025".

THICKNESS: .0045" to .0050".

WEIGHT: 20 lb. \pm 5% (17" x 22" - 500 sheets).

CONTENT: 100% bleached chemical woodpulp.

MOISTURE EXPANSIVITY: .20% cross direction and .07% machine direction maximums using TAPPI** T 447m test.

REFLECTANCE: The reflectance reading must be at least 50 millivolts.

OPACITY: When reflectance measurements are made from the back of the document, the difference in reflectance between a printed and a non-printed area should not exceed 7 millivolts.

TWO-SIDE PRINTING: Documents printed on both sides must maintain the same right-hand reference edge. These documents must be printed in tumble mode.

CORNER CUT: Paper documents to be read by the IBM 1231 and 1232 should have an upper right-hand corner cut. This corner cut should be at an angle of $30^{\circ} \pm 2^{\circ}$ relative to the right-hand edge of the document. The length of the cut along the top edge must be .215" \pm .025". Additional cuts are required if documents printed on both sides are used.

Burst Continuous Forms

Continuous forms that are used (after bursting) as input to either the IBM 1231 or the IBM 1232 must conform to the requirements shown in Figure 30 in addition to the requirements for regular paper forms.

CORNER CUT

Documents should have a corner cut in upper-right

corner. The corner cut should be at an angle of 30° relative to the right edge of the document. The length of the corner cut along the top edge must be .215" \pm .025". The top of the corner cut can end at the top edge of the document or may extend a maximum of .030" into the bottom of the document above. The right edge of the corner cut can end at the right edge of the document or may extend into the adjacent carrier strip a maximum of .046".

PERFORATIONS

Burst continuous forms must be grain long with cross perforations of either 6 or 8 cuts per inch with .032" ties. All running (vertical) perforations must be four cuts per inch with .032" ties. The leading edge must be free of "hang-on" and creases or fold marks. Neither vertical perforations nor the bottom cross perforations can have hang-on that exceeds 1/16" x 1" in area. Hang-on must not occur more than once every 25 documents.

CARRIER STRIPS

Measured from center to center, the distance between any two adjacent carrier strip holes must be .500" \pm .005".

If cutters are used to remove carrier strips during a bursting operation, care must be taken to maintain the 8 1/2" \pm .015" document width.

SKEW REQUIREMENT

When a straight line is drawn perpendicular to the right edge of any document, tangent to the top edge of one of the marking positions of any row, the maximum vertical distance between the top edge of any other marking position in that row and this perpendicular line should be .010".

NOTE: The perpendicular line is referred to throughout this publication as the "marking line".

DOCUMENT TO DOCUMENT DIMENSIONS

The vertical distance between corresponding marking positions on vertically adjacent forms is 11.000". The vertical distance between the top carrier strip hole (top edge of hole) and the first marking line must be within \pm .015" and be consistent from document to document. The \pm .010" skew tolerance must be included within this .015" tolerance.

If the form is designed with four rows to the inch, every other row should have the same measurement

*Kidder Press Co., Dover, New Hampshire

**Technical Association of the Pulp and Paper Industry

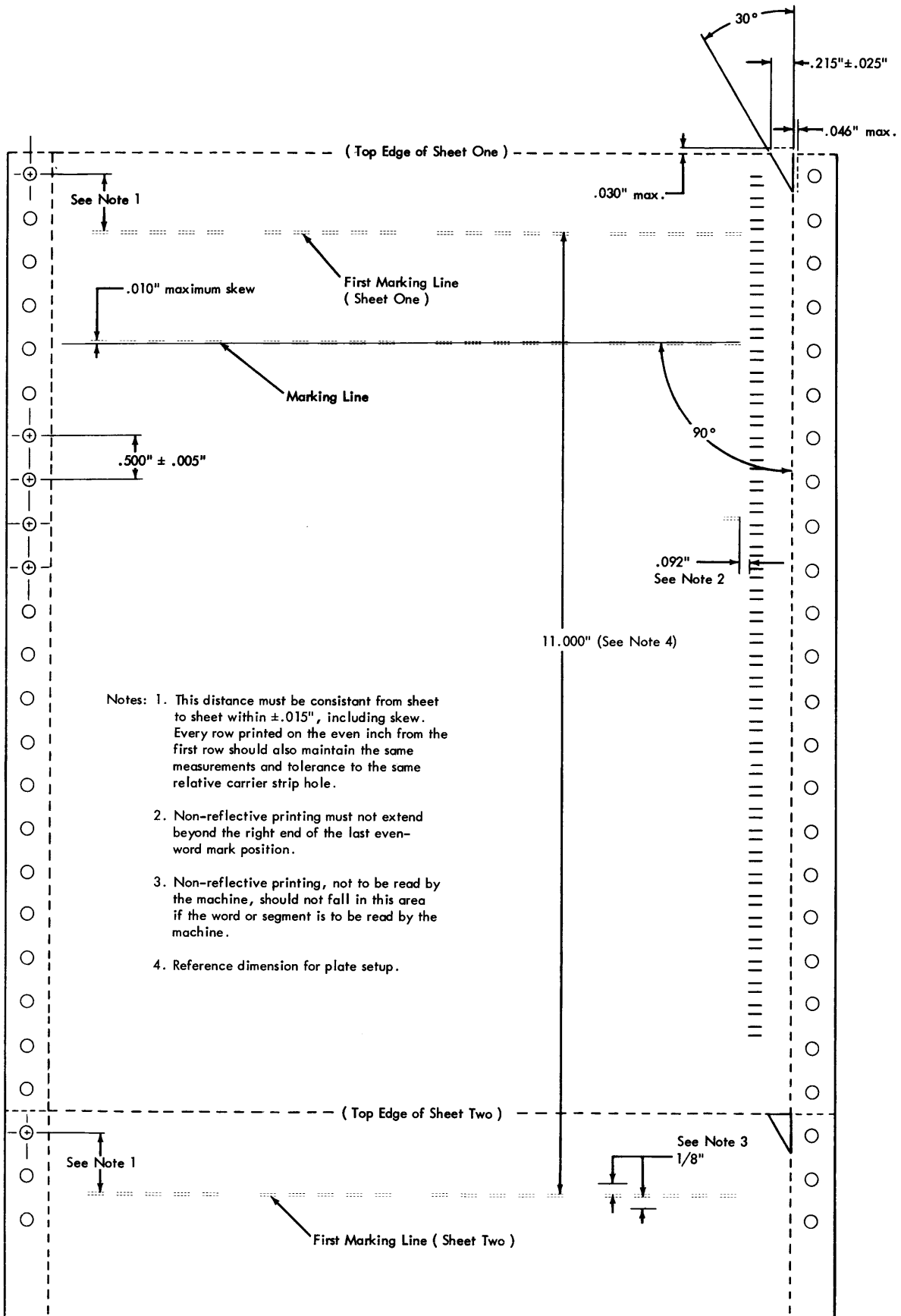

● Figure 30. Continuous Forms Dimensions

between the top of the carrier hole and the relative marking line, and be subject to the same tolerance as the first marking line.

Ink Requirements

Timing marks must be printed on the data sheet in non-reflective ink. Black is recommended. The reflectance reading must not exceed 30 millivolts.

Information that is not to be read by the 1231/1232 must be printed in reflective ink. An ink reflectance of at least 48 millivolts is required. The reflectance of the ink must not vary more than 7 millivolts from the reflectance of the paper.

No non-reflective printing or writing should be contained within an area from 1/8" above to 1/8" below a word that is programmed to read.

Document Format Requirements

The maximum number of mark positions on any one side of a document is 1000. To obtain this maximum number, the rows of words on the data sheet must be printed five to the inch (vertically). If the rows are printed four to the inch, 800 is the maximum number of mark positions.

Whenever a new data sheet is to be designed for use by the 1231/1232, three standard layout forms are available for use as design guides. Form X20-8043 is designed with five rows per inch; Form X20-8044 is designed with four rows per inch; and X20-8045 is designed with three rows per inch. Design of answer sheets for test scoring should use Forms X20-8040, X20-8041, or X20-8042. Any combination of these forms may be employed as long as the timing marks maintain their relationship to the row and the rows are never printed closer than the minimum of .200" spacing. Two timing marks should be printed for every row of words; the timing marks are used to trigger the read head from odd word to even word to odd word, etc.

No marks, other than timing marks, should be present in the timing mark area. A reading of an extra timing mark, or failure to read a timing mark, would cause the read heads to lose synchronism with the data sheet words (Reading would take place between the rows rather than on the rows).

NOTE: To familiarize persons not aware of proper marking techniques, instructions of the following nature should be printed on all data sheets:

Make your marks with a black lead pencil.

Erase completely any marks you wish to change.

Printing Requirements

The length of a timing mark must be .156" \pm .010"; its width .020" \pm .003" (Figure 31). The dimensions of the master mark are .250" \pm .015" in length and .020" \pm .003" in width. Other horizontal dimensions of the data sheet are shown in Figure 32.

The outline of a mark position measures .190" \pm .010" in length. The vertical distance between the top edges of two outlining guide lines of a mark position should be .032" \pm .005" (Figure 33). The line width of the guide lines should be .005" to .008".

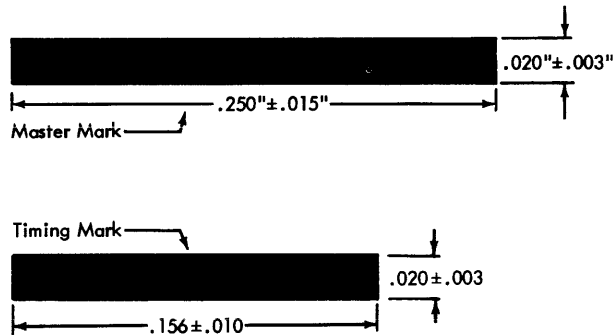

Figure 31. Timing Mark and Master Mark Dimensions

A segment is composed of five, data-mark positions. The length of a segment is 1.510" \pm .005". All segment dimensions are shown in Figure 34: All words must be perpendicular to the reference edge (Figure 35), and must be vertically spaced at least .200" \pm .005" apart.

TWO-SIDE PRINTING

Both sides of a document can be used; however, only one side can be scanned during a single pass through the reader.

Documents printed on both sides must maintain the same right-hand reference edge. Thus, all documents must be printed in tumble mode. When looking through a document, all response positions and timing marks should coincide.

An additional and identical corner cut is required when both sides of a document are used. Therefore, two corners will be cut; the upper right and the lower right. A third corner cut is recommended in the upper left-hand corner to ensure the same "up" side on all documents.

IBM 1403/1443 MARK PRINTING REQUIREMENTS

Marks (dashes) printed by an IBM 1403 Printer, Model 1, 2, 4, 5, 6, or 7; or by an IBM 1443 Printer, Model 1 or 2, can be read by the IBM 1231/1232 Optical Mark Page Readers if a special dash character is substituted for the standard dash character. For the 1443, any of the 52 character typebars or the 63 character typebar can be used. The segment containing the standard dash is replaced by a segment containing the special dash. The 13 and the 39 character typebars cannot be used. In the 1403, the standard dash characters are replaced by special dash characters.

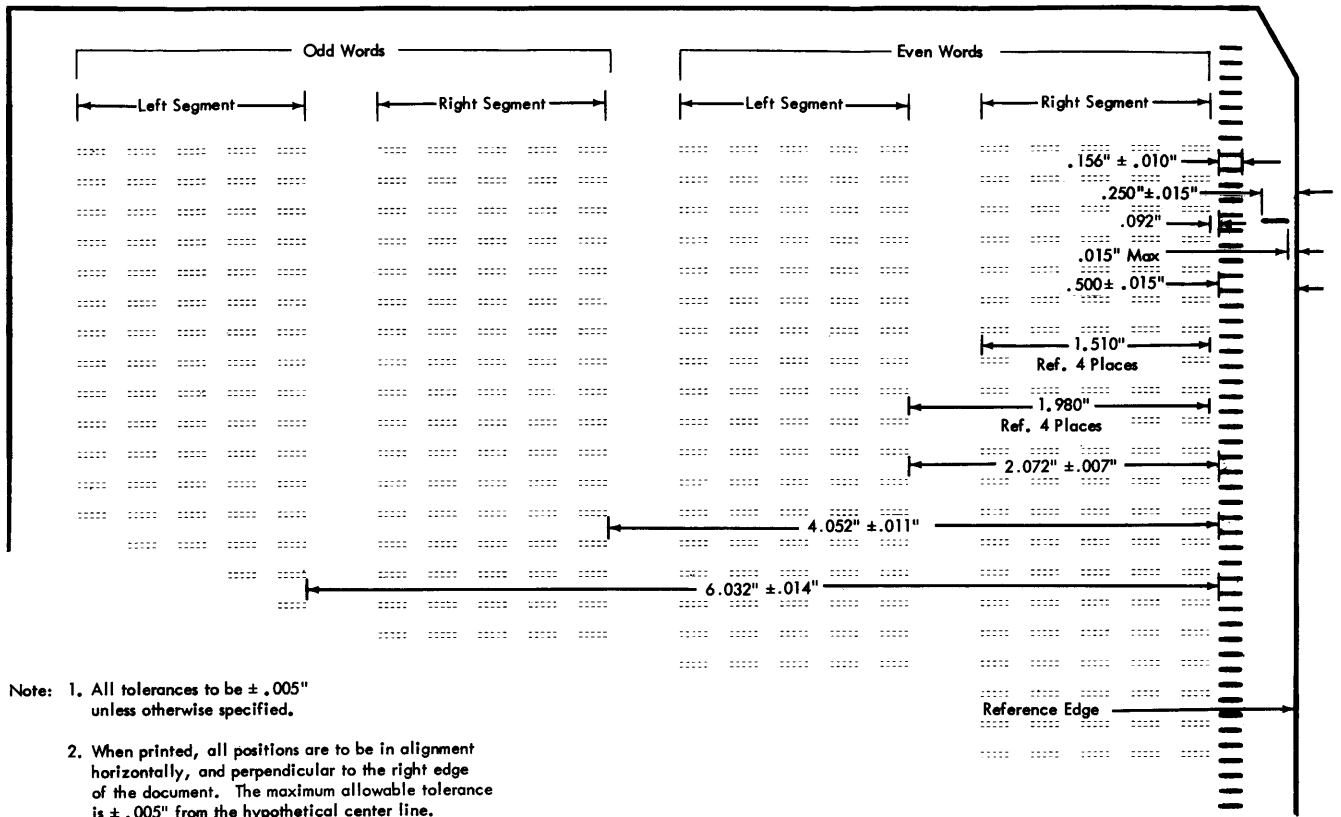

Figure 32. Horizontal Dimensions

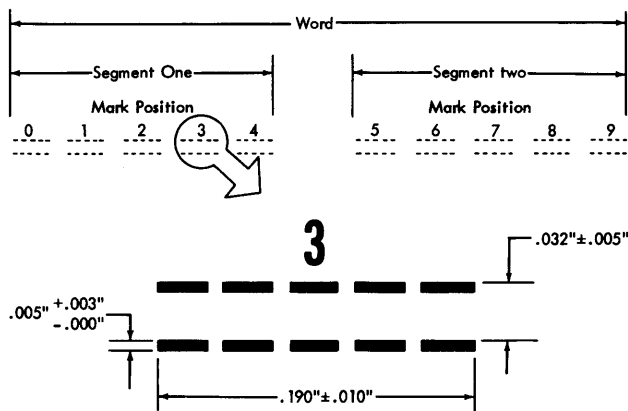

Figure 33. Mark Position Dimensions

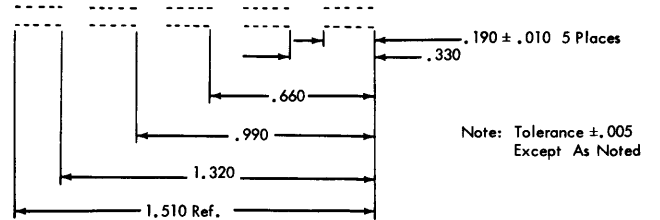

Figure 34. Segment Dimensions

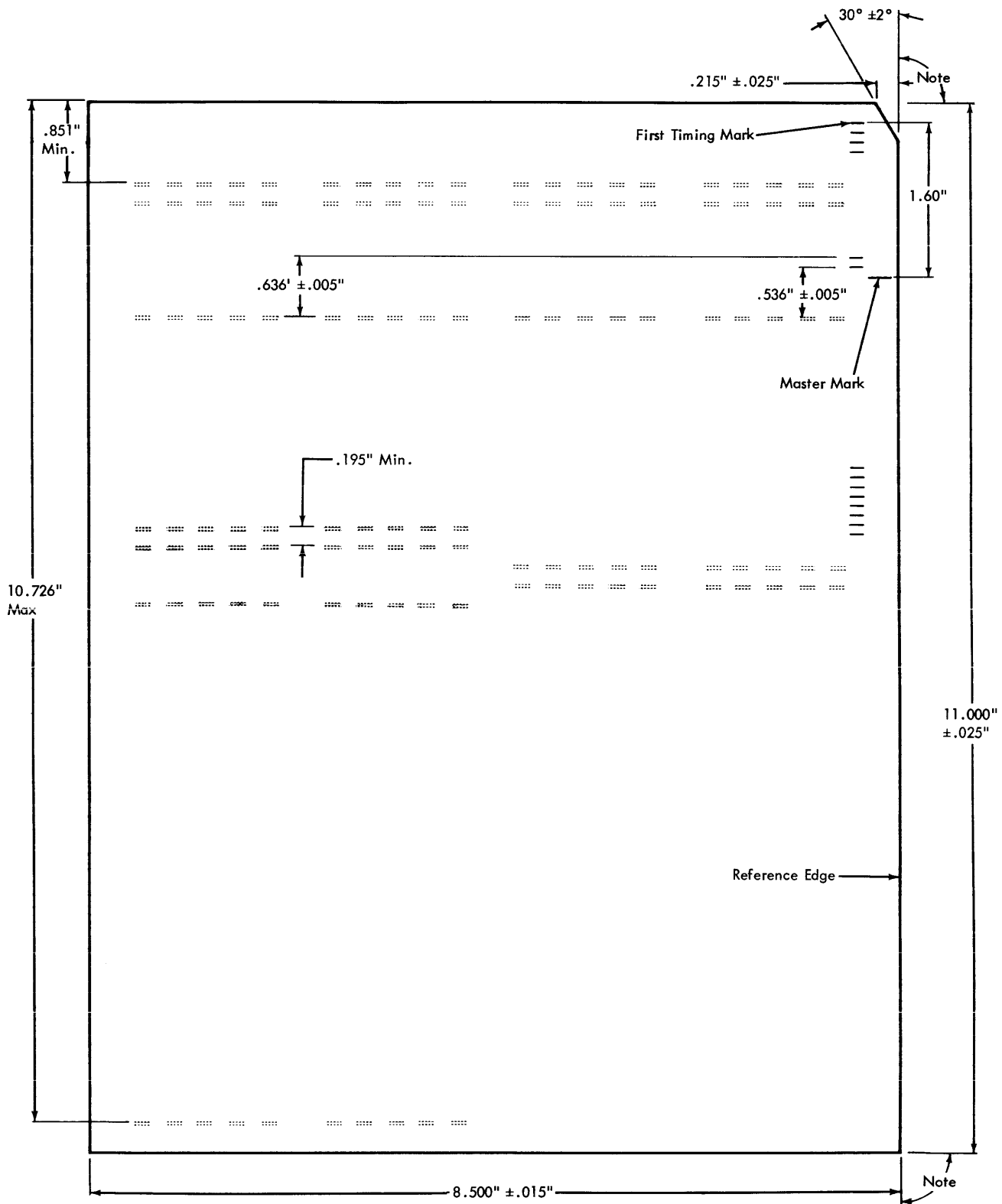

Figure 9. Vertical Dimensions

Note: The bottom and top edge should be perpendicular to reference edge within $.015$ inch as measured at left edge.

Figure 35. Vertical Dimensions

To be usable by the 1403 or the 1443 printers, the words on the data sheet must have vertical spacing compatible to the line spacing of the printer. The maximum vertical density readable by the 1231 or the 1232 is five rows per inch. Both the 1403 and the 1443 normally print either six or eight lines to the inch; therefore, that portion of the 1231/1232 document which is to have marks printed by the printers should be printed with either three or four rows per inch. Any one document can, for instance, be printed so that the portion to have machine printed marks could be printed at four rows per inch and the balance of the document could be printed at five rows per inch. The timing marks, in this case, must be printed so that they maintain the proper relationship to the word to be read.

IBM ribbons 474635 (1403-11"), 474634 (1403-14"), 422536 (1443), or their equivalents can be used for the printing of marks in mark positions. Marks which produce a reflectance reading of 37 millivolts or less (as measured by a Kidder Mark Read Tester) can be read reliably by the 1231/1232. As the ribbon is used, the reflectance reading of the printed marks increases. Therefore, during any mark printing run, some method of monitoring the reflectance reading of the printed marks is necessary.

One method of indirectly monitoring the reflectance is to keep track of the number of lines printed by any one ribbon. The 1403 ribbons will print 150,000 lines of marks when the same mark position is marked on every row; 1,500,000 lines when only one mark position is printed per word and the marks are evenly dispersed across the word. The 1443 ribbon will print 1,200,000 total characters before the 37 millivolt maximum reading is reached. Each mark position requires two or three dash characters, depending on the mark position being printed.

NOTE: When reading documents that have been printed with two or more marks per segment or word, the read mode switch must be set to MULTI RESP. This setting allows all marks which fall into either area A or

area B as shown in Figure 9 (see *Mark Recognition and Discrimination* section) to be read without discrimination. The MULTI RESP SEL UNC setting should not be used when reading multiple marks made by printers. When reading documents printed with one mark per word or segment, the read mode switch must be set at SING RESP.

Because the horizontal dimension between adjacent mark positions (measured center to center) is .330", and the horizontal pitch of the 1403 or 1443 printers is ten characters per inch, the printed marks will not print symmetrically within the mark positions (Figure 36). Each mark position to be marked on the 1231/1232 document must contain at least two printed dashes to ensure that a proper amount of non-reflective ink exists within the marking area of that position; some positions must contain three printed dashes to meet the non-reflective ink requirements. Three dashes are required in odd-word positions 0, 4, 6, and 9, and in even-word positions 2, 5, and 8. See Figure 36. Printer positions 1 through 75 are assumed for purposes of illustration only. If it is desired to use other printer positions, the same relationship must be maintained between the printed dashes and the mark positions.

Setting up the printers requires that the horizontal and vertical alignment be accurate and the printing impact be correct. The procedure for setting up the 1403 or the 1443 printer is:

1. a. Set the 1403 print density to "A".
b. Set the 1443 print density to "2".
2. a. Set the 1403 print timing dial for the proper paper thickness. The 1231/1232 document is .0045" to .0050" thick.
b. Adjust the 1443 paper brake for proper paper tension.
3. Align the 75th print position horizontally so that the right end of the printed dash is flush with the right end of the last even-word mark position guide lines. If only the odd words are to be printed, align the 29th print position dash with the right edge of response position #7.

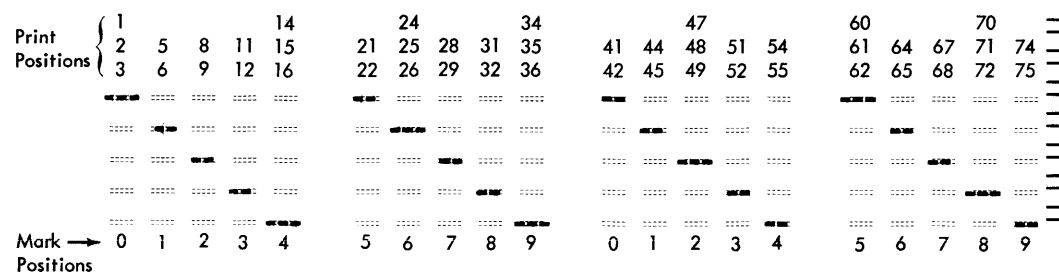

Figure 36. Horizontal Placement of Printed Marks

4. Center the dashes vertically within the mark position guide lines. At least .015" of the printed dash *must* fall within the guide lines.

Information which is not to be read by the 1231/1232 (such as customer number, salesman number, part description, etc.), although usually printed in reflective ink, can be printed in non-reflective ink at the same time that the marks are being printed in the mark positions. These rules apply:

1. Information must not be printed in non-reflective ink within an area extending from 1/8" above to 1/8" below any word which is to be read by the 1231 or the 1232.
2. The information must be printed at least .092" from the left edge of the nearest timing mark.

During the printing operation, check the horizontal and vertical mark printing registration. The printing registration must be carefully maintained to ensure 1231/1232 reading reliability.

Design Guides

Many factors must be considered when designing a new data sheet. The format affects items such as throughput, field checking, usage of cards, etc. The following factors should be considered:

- All documents are read left to right, top to bottom, row by row.
- Timing marks synchronize the read head with the data being read. Two timing marks are required for any row in which either or both words may be marked.
- The number of master-mark words marked on a master-mark data sheet must equal the number of card columns reserved for punching master-mark data in the card. The number of timing marks printed on the master-mark sheet must be twice as great as the number of words marked. (Only even words are read on the master-mark sheet.)
- Identification data (available with the Multiple Spread-Card or Unit Record Card features), if called for by the 534 program card, reads out in the sequence it was read, regardless of whether or not it was mixed with detail data when read from the data sheet.
- When the Segmented Word feature is installed on a 1232 (standard on a 1231), information can be read and punched on a segment basis. One, neither, or both segments of any word on the data sheet may be programmed to read. Master-mark data and identification data always punch on a word per column basis, regardless of the setting of the punch mode switch.

- Field checking is controlled by switches. Start-of-checking control codes (stored from the program control sheet) determine which set of field checking switches is to be used for checking the field. Any of the three sets of field checking switches can be programmed, on the program control sheet, to be active in the sequence necessary for processing the data sheet.

- Detail data must be the last data punched (1232/534). Whenever two or more choices are given as response to a question or item, marks should be kept within one segment or word so that the field check switches can check for any or all select conditions.
- In applications where it may be necessary to mark long series of numbers on a data sheet, it is helpful to overprint a shadow line (a screened stripe) on every other row. This enables the person marking the sheet to visually scan each row for a mark.

Document Gage

A document inspection gage (Figure 37), is available for checking printing alignment on a data sheet. The procedure for using the gage is:

1. Position right edge of document against reference edge of gage, and bottom edge of document against document length reference line on gage. Check that:
 - a. Left edge of timing mark is under timing mark skew tolerance line.
 - b. Left edge of document is under document width tolerance line.
 - c. Top edge of document is under or between document length tolerance lines.
2. With document still positioned against gage reference edge, slide document as needed to check that:
 - a. Top and bottom edges of document are within document squareness tolerance lines.
 - b. Corner-cut of document is under angular and width corner-cut tolerance line.
 - c. Top edges of all response positions in a horizontal row fall between response skew tolerance lines.
 - d. Top of form is under or between document length tolerance lines when top edges of first and second word response positions are under first response reference lines. Top edge of first two timing marks should fall under the two timing mark spacing lines near corner-cut tolerance line.
 - e. Top edges of last two word-response positions fall under or between first-last response tolerance lines when top edges of first two word-response positions are under first response reference lines.

Figure 37. Document Gage

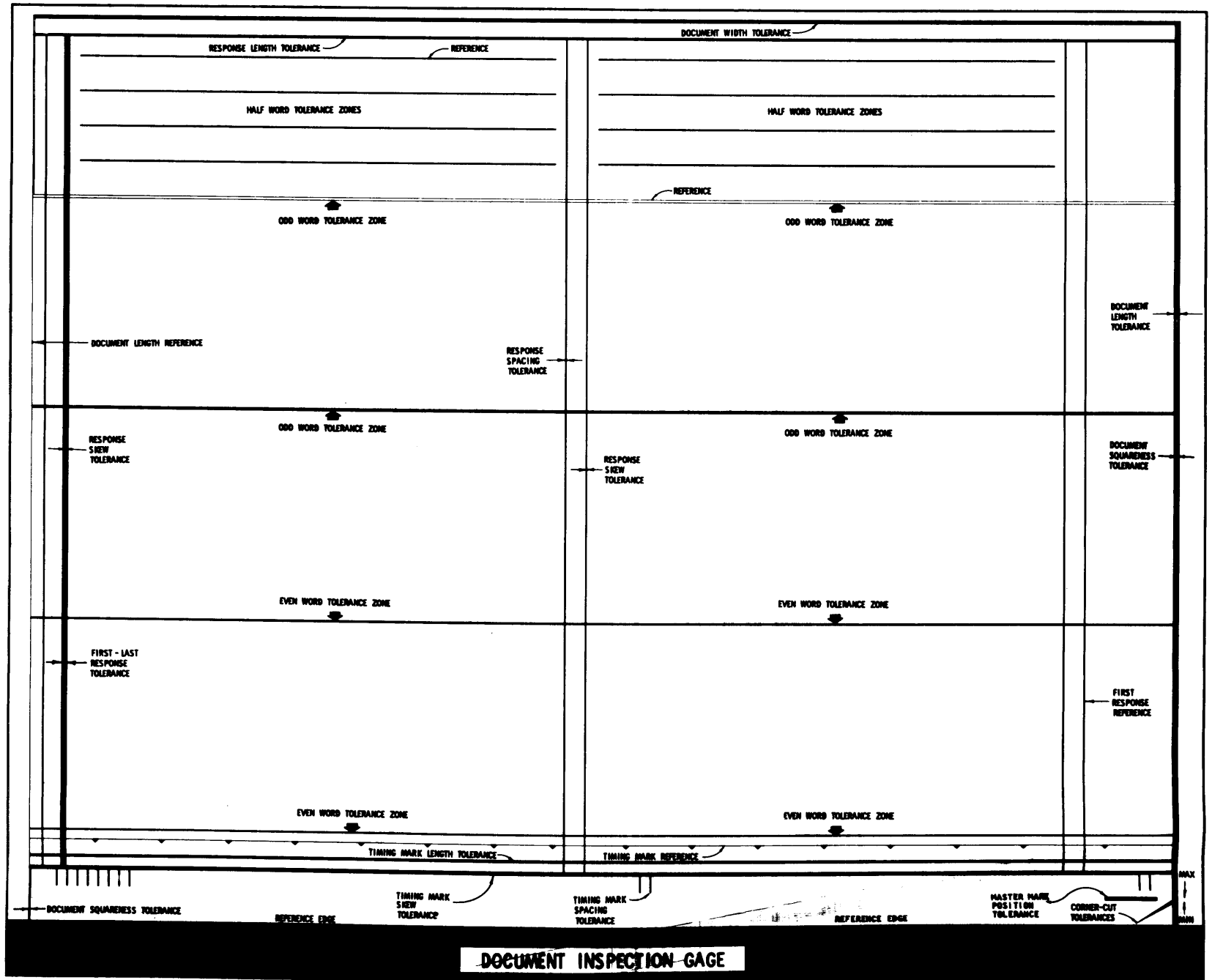

- f. Top edges of timing marks fall under two timing mark spacing tolerance lines on gage when top edge of response position is between response skew tolerance lines (as reference). Response spacing can also be checked at this time.
 - g. With the right edge of the data sheet against the reference edge of the gage and the top control timing mark (1230) aligned with the fine line timing mark on the gage, the top of the adjacent timing marks must fall under the timing marks on the gage.
3. Reposition document so left edge of timing marks just touch the timing mark reference line. Check that:
- a. Edges of printed response positions fall under appropriate tolerance zone lines. This checks odd and even word tolerances (right edge of 5th and 10th response positions in odd and even words).
 - b. Right edge of timing mark falls under timing mark length tolerance line.
4. Align right edge of fifth or tenth response position under reference line of odd word tolerance zone. Check that:
- a. Right edge of first four response positions of the half word are under respective half word tolerance zone line.
 - b. Left edge of response position is under response length tolerance line when right edge of response position is under reference line (near top of gage).

Index

Alphabetic Coding	19	Normal Stacker	11, 26
Auto Feed Switch, 534	38	Odd Words	8
Auto Punch/Keypunch Switch, 534	38	On-Demand Feed Mode	24
Auto Skip/Dup Switch, 534	38	On-Line Program Instructions	26
Bits	14	On-Line Systems Programming	24
Burst Continuous Forms	42	Operating Procedures	27
Card Number	32	Paper Requirements	42
Card Punch, 534	5, 10, 13, 14, 38	Parity Checks	14
Carrier Strips	42	Perforations	42
Check Length Switches	21	Photocell	12
Computer Processing	5	Positional Marks	5
Computer Storage	13, 31	Printing Requirements	44
Continuous Feed Mode	24	Process Check Light	21
Controls	19	Processing, Computer	5
Control Timing Mark Switch	21	Program Card, 534	15, 22, 32, 38
Corner Cut	42	Program Control Sheet	10, 12, 22
Data Flow	13, 14	Program Load Cycle	22
Data Sheet	5, 8, 12, 16, 40, 44	Program Load Key	20
Delay Line	13	Programming	22, 38
Design Guides, Document	48	Punch Check Light	21
Detail Data	14, 32, 34, 48	Punch Controls	38
Digit Value	14	Punch Mode Switch	21, 31, 32
Document Cycle	5	Punch-On Light	38
Document Design and Specification	42	Punch Program Codes	38
Document Dimensions	42	Reading	12
Document Format Requirements	40, 44	Read Instruction	24, 26
Document Gage	48	Read Mode Switches	13, 21
Document Path	10	Read Unit	12
Documents	5, 8	Refeed Sel Doc Light	21
End-Of-Field Marks	16, 48	Reflectance	42
End-Of-Group Marks	22, 34	Reflective Ink	8, 20
Erasures	8, 13	Reset Key	20, 26
Even Words	8	Restart Procedures	28
Feed and Transport Mechanism	10	Segmented Word Feature	15, 22, 31
Feed Check Light	21, 28	Segments	8, 31
Feed Hopper	10, 28	Select Condition Switches	21
Feed Key, 534	38	Selector Station and Stackers	11
Feed Mode Switch	20	Select Stacker	11, 26
Feed Rolls	10	Setup, 534	27
Field Checking	16, 48	Setup, 1231	27
IBM 1232/534 Synchronization Check	15, 38	Setup, 1232	27
Identification Data	22, 31, 32, 34	Sheet Feed	38, 40
Ink Requirements	44	Skew Requirements	42
Keyboard, 534	38	Special Card Features	31
Keys and Switches	20	Special Features	31
Layout Forms	8, 44	Specifications, Document	42
Lights	21	Spread Card	22, 32
Mark Recognition and Discrimination	12	Start Key	20, 21
Mark Positions	8, 12	Stop Key	20
Mark-Printing Requirements, 1403/1443	44	System Stopped Light	21, 29
Marks	8, 12, 13, 27, 44	Throughput, 1231	40
Master Data Sheet	31	Throughput, 1232/534	40
Master Mark Data	13, 14, 31, 48	Timing Mark Check Switch	21
Master Mark Feature	22, 31	Timing Marks	8, 12, 44, 48
Master Mark Switch	20	Transport	10
Message Format	14, 15	Two-Side Printing	44
Moisture Expansivity	42	Uncertainty	13, 21
Multi-Marks	16	Unit Record Card Feature	16, 22, 34
Multiple Spread Card Feature	16, 22, 32	Unit Record Card Switch	21
Non-Reflective Inks	8	Words	8, 12, 22

READER'S SURVEY FORM

Manual Name: IBM 1231, 1232 Optical Mark Page Readers

Form No. A21-9012-3

- Is the material:

	<i>Yes</i>	<i>Satisfactory</i>	<i>No</i>
Easy to read?	<input type="checkbox"/>	<input type="checkbox"/>	<input type="checkbox"/>
Well organized?	<input type="checkbox"/>	<input type="checkbox"/>	<input type="checkbox"/>
Fully covered?	<input type="checkbox"/>	<input type="checkbox"/>	<input type="checkbox"/>
Clearly explained?	<input type="checkbox"/>	<input type="checkbox"/>	<input type="checkbox"/>
Well illustrated?	<input type="checkbox"/>	<input type="checkbox"/>	<input type="checkbox"/>

- How did you use this publication?

As an introduction to the subject	<input type="checkbox"/>
For additional knowledge of the subject	<input type="checkbox"/>

- Which of the following terms best describes your job?

<i>Customer Personnel</i>	<input type="checkbox"/>	<i>IBM Personnel</i>	<input type="checkbox"/>
Manager	<input type="checkbox"/>	Customer Engineer	<input type="checkbox"/>
Systems Analyst	<input type="checkbox"/>	Instructor	<input type="checkbox"/>
Operator	<input type="checkbox"/>	Sales Representative	<input type="checkbox"/>
Programmer	<input type="checkbox"/>	Systems Engineer	<input type="checkbox"/>
Trainee	<input type="checkbox"/>	Trainee	<input type="checkbox"/>
Other _____		Other _____	

- Check specific comment (if any) and explain in the space below:

(Give page number)

- | | |
|--|--|
| <input type="checkbox"/> Suggested Change (Page)) | <input type="checkbox"/> Suggested Addition (Page)) |
| <input type="checkbox"/> Error (Page)) | <input type="checkbox"/> Suggested Deletion (Page)) |

Explanation:

Tear Along Line

Space is available on the other side of this page for additional comments.
Thank you for your cooperation.

Staple

Staple

Fold

Fold

FIRST CLASS
 PERMIT NO. 387
 ROCHESTER, MINN.

BUSINESS REPLY MAIL
 NO POSTAGE NECESSARY IF MAILED IN THE UNITED STATES

POSTAGE WILL BE PAID BY . . .

IBM Corporation
 Systems Development Division
 Development Laboratory
 Rochester, Minnesota 55901

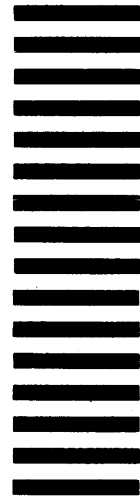

Cut Along Line

Attention: Product Publication, Dept. 245

Fold

Fold

Additional Comments:

IBM

**International Business Machines Corporation
Data Processing Division
112 East Post Road, White Plains, N.Y. 10601**